

AIRCRAFT OPERATING INSTRUCTIONS

Light Sport Aircraft

EDGE XT 582-L – CRUZE-L MICROLIGHT

Approved: 

Date: 17 May 2007

Delegate of AirBorne WindSports Pty Ltd



Serial No. Base	XT582	
Serial No. Wing		
Registration No.		

This manual is compliant with the ASTM designation f2457 – 05 Standard Specification for Required Product Information To Be Provided With Weight-Shift-Control Aircraft.

AirBorne WindSports Pty Ltd

UNIT 22/30 KALAROO ROAD, REDHEAD, NSW 2290 AUSTRALIA

Phone (02) 4944 9199 International +61 2 4944 9199

Fax (02) 4944 9395 International +61 2 4944 9395

Email fly@airborne.com.au

www.airborne.com.au

This page left blank intentionally

AIRCRAFT OPERATING INSTRUCTIONS - DETAILS

Aircraft Operating Instructions	
Issued By	
Date	
For AirBorne WindSports Pty. Ltd.	

Table 1 Section 0. Aircraft Operating Instructions

MANDATORY SERVICE BULLETINS

AS THE SERVICE HISTORY OF THE AIRFRAME EVOLVES AIRBORNE WILL FROM TIME TO TIME ISSUE MANDATORY SERVICE BULLETINS WHICH DETAIL ANY CHANGES TO THE MAINTENANCE MANUALS, AIRCRAFT OPERATING INSTRUCTIONS, OR ANY OTHER DETAILS THAT AIRBORNE DEEMS NECESSARY FOR OWNERS TO BE NOTIFIED OF.

THE WEB ADDRESS FOR SERVICE BULLETINS IS:

[HTTP://WWW.AIRBORNE.COM.AU/](http://www.airborne.com.au/)

IT IS THE RESPONSIBILITY OF THE OPERATOR TO KEEP UP TO DATE WITH ANY ROTAX DIRECTIVES THROUGH THE ROTAX WEBSITE.

DATA PACKAGE

This issue of the Aircraft Operating Instructions constitutes one part of the complete data package that accompanies the aircraft. Following is a list of each of the components which are required.

- **Aircraft Operating Instructions**
- **XT 582 Maintenance Manual**
- **XT 582 Illustrated Parts Catalogue**
- **Wing Maintenance Manual**
- **Wing Illustrated Parts Catalogue**
- **Rotax Owners Manual**
- **Rotax Maintenance (Compact Disk)**
- **Radio Manual – If Installed**
- **BRS Parachute Manual – If Installed**

+

Table 2 Section 0. XT 582 Cruze Data Package

Certification documentation is held by the aircraft manufacturer,
 Contact Information:

Airborne WindSports Pty Ltd
 PO Box 7042 Redhead
 NSW 2290
 Australia

Telephone +61 2 49449199
 Web address: <http://www.airborne.com.au>

Or for recovery of the certification documentation, should the above contact not be available; contact the Civil Aviation Safety Authority of Australia.
 Website

<http://www.casa.gov.au/>

AMENDMENT RECORD SHEET

Amendment Date	Affected Sections	Affected Pages	Date Inserted	Signature

Manuals will be revised from time to time and reissue of amended pages will be achieved by sending the pages to the current owner registered on AirBorne's database. Amendments will also be available on the Airborne Website (<http://www.airborne.com.au/>). The amended pages should be printed and the prior page replaced in the manual's folder as soon as possible. The amendment table should at that time be updated with the appropriate details and date.

Table 3 Section 0. Amendment Record Sheet

LOG OF EFFECTIVE PAGES

Page	Issue	Date	Page	Issue	Date	Page	Issue	Date
0-1	Issue 2.0	May 2007	3-1	Issue 2.0	May 2007	5-1	Issue 2.0	May 2007
0-2	Issue 2.0	May 2007	3-2	Issue 2.0	May 2007	5-2	Issue 2.0	May 2007
0-3	Issue 2.0	May 2007	3-3	Issue 2.0	May 2007	5-3	Issue 2.0	May 2007
0-4	Issue 2.0	May 2007	3-4	Issue 2.0	May 2007	5-4	Issue 2.0	May 2007
0-5	Issue 2.0	May 2007	3-5	Issue 2.0	May 2007	5-5	Issue 2.0	May 2007
0-6	Issue 2.0	May 2007	3-6	Issue 2.0	May 2007	5-6	Issue 2.0	May 2007
0-7	Issue 2.0	May 2007	3-7	Issue 2.0	May 2007	6-1	Issue 2.0	May 2007
0-8	Issue 2.0	May 2007	3-8	Issue 2.0	May 2007	6-2	Issue 2.0	May 2007
1-1	Issue 2.0	May 2007	4-1	Issue 2.0	May 2007	6-3	Issue 2.0	May 2007
1-2	Issue 2.0	May 2007	4-2	Issue 2.0	May 2007	6-4	Issue 2.0	May 2007
1-3	Issue 2.0	May 2007	4-3	Issue 2.0	May 2007	6-5	Issue 2.0	May 2007
1-4	Issue 2.0	May 2007	4-4	Issue 2.0	May 2007	6-6	Issue 2.0	May 2007
1-5	Issue 2.0	May 2007	4-5	Issue 2.0	May 2007	7-1	Issue 2.0	May 2007
1-6	Issue 2.0	May 2007	4-6	Issue 2.0	May 2007	7-2	Issue 2.0	May 2007
1-7	Issue 2.0	May 2007	4-7	Issue 2.0	May 2007	7-3	Issue 2.0	May 2007
1-8	Issue 2.0	May 2007	4-8	Issue 2.0	May 2007	7-4	Issue 2.0	May 2007
2-1	Issue 2.0	May 2007	4-9	Issue 2.0	May 2007	7-5	Issue 2.0	May 2007
2-2	Issue 2.0	May 2007	4-10	Issue 2.0	May 2007	7-6	Issue 2.0	May 2007
2-3	Issue 2.0	May 2007	4-11	Issue 2.0	May 2007	7-7	Issue 2.0	May 2007
2-4	Issue 2.0	May 2007	4-12	Issue 2.0	May 2007	7-8	Issue 2.0	May 2007
2-5	Issue 2.0	May 2007	4-13	Issue 2.0	May 2007	7-9	Issue 2.0	May 2007
2-6	Issue 2.0	May 2007	4-14	Issue 2.0	May 2007	7-10	Issue 2.0	May 2007
2-7	Issue 2.0	May 2007	4-15	Issue 2.0	May 2007	8-1	Issue 2.0	May 2007
2-8	Issue 2.0	May 2007	4-16	Issue 2.0	May 2007	8-2	Issue 2.0	May 2007
2-9	Issue 2.0	May 2007	4-17	Issue 2.0	May 2007	8-3	Issue 2.0	May 2007
2-10	Issue 2.0	May 2007	4-18	Issue 2.0	May 2007	8-4	Issue 2.0	May 2007
2-11	Issue 2.0	May 2007	4-19	Issue 2.0	May 2007	8-5	Issue 2.0	May 2007
2-12	Issue 2.0	May 2007	4-20	Issue 2.0	May 2007	8-6	Issue 2.0	May 2007
2-13	Issue 2.0	May 2007	4-21	Issue 2.0	May 2007	9-1	Issue 2.0	May 2007
2-14	Issue 2.0	May 2007	4-22	Issue 2.0	May 2007	9-2	Issue 2.0	May 2007
2-15	Issue 2.0	May 2007	4-23	Issue 2.0	May 2007	9-3	Issue 2.0	May 2007
2-16	Issue 2.0	May 2007	4-24	Issue 2.0	May 2007	9-4	Issue 2.0	May 2007
2-17	Issue 2.0	May 2007	4-25	Issue 2.0	May 2007	9-5	Issue 2.0	May 2007
2-18	Issue 2.0	May 2007	4-26	Issue 2.0	May 2007	9-6	Issue 2.0	May 2007
2-19	Issue 2.0	May 2007	4-27	Issue 2.0	May 2007			
2-20	Issue 2.0	May 2007	4-28	Issue 2.0	May 2007			
2-21	Issue 2.0	May 2007	4-29	Issue 2.0	May 2007			
2-22	Issue 2.0	May 2007	4-30	Issue 2.0	May 2007			

Table 4 Section 0. Log Of Effective Pages

CONTENTS

1 GENERAL

2 LIMITATIONS

3 EMERGENCY PROCEDURES

4 NORMAL PROCEDURES

5 PERFORMANCE

6 WEIGHT BALANCE AND EQUIPMENT

7 AIRCRAFT & SYSTEMS DESCRIPTION

8 HANDLING SERVICE AND MAINTENANCE

9 SUPPLEMENTS

This page left blank intentionally

CONTENTS OF GENERAL SECTION 1

1 GENERAL	2
1.1 Introduction	2
NOTE	2
1.1.1 Warning Notice	3
1.1.2 Definitions	3
1.2 General Description	4
1.1.3 Two View Photos	4
1.1.4 General Dimensions	5
1.1.5 General Description	5
1.2 Symbols Abbreviations and Terminology	7
1.3 Use of metric / imperial units	8

1 GENERAL

This document, Aircraft Operating Instructions (AOI) has various sections to comply with the General Aviation Manufacturers Association (GAMA) handbook specification. The GAMA format has been adopted and used where applicable for this weight shift controlled microlight.

The AOI contains information for the XT 582 base coupled with the Cruze wing.

1.1 Introduction

This microlight series has been designed and manufactured in accordance with the ASTM designation 2317-04 Standard Specification for Design of Weight-Shift-Control Aircraft.

The aircraft has also been designed to the higher level of certification requirements for weight shift controlled aircraft. The design standard of BCAR Section S, has been used for certification as a primary category aircraft.

As an Australian Company, we are proud of our range of microlight aircraft. Our microlights have been developed to provide the economy and durability required to meet the exacting demands of our Australian conditions.

The success of our microlights is based upon a high standard of product quality, innovative design engineering and exceptional standards of reliability and performance that have been established since 1983.

Regular maintenance is required to keep your microlight in a safe condition. Detailed maintenance requirements are outlined in the Wing and Base maintenance manuals. Please reference these manuals to ensure your microlight is maintained correctly.

In the USA, the FAA registers and administers Light Sport Aircraft.

The AirBorne Team has developed from the long-standing friendship of a group of enthusiasts who share conviction in the intrinsic advantages of weight shift controlled aircraft. The AirBorne Team is confident your new microlight will provide you with many years of enjoyable flying, and we wish you and your family safe and happy flying for the future. The operating procedures outlined in these Aircraft Operating Instructions are the result of AirBorne's knowledge and experience gained since 1983.

NOTE

AirBorne data packages will be revised from time to time. It is therefore important that owners promptly notify Airborne of any changes to their contact details. Owners registered on AirBorne's database will be notified of any changes to data and directed to the AirBorne web site (<http://www.airborne.com.au/>) for the applicable pages. The amended pages should be printed and the replacement pages inserted in the folder as soon as possible. The amendment table should at that time be updated with the appropriate details and date. Revised pages will be sent by mail if requested from AirBorne WindSports, the contact details are at the front of this manual.

1.1.1 Warning Notice

WARNING

THERE ARE INHERENT RISKS IN THE PARTICIPATION IN RECREATIONAL AVIATION AIRCRAFT. OPERATORS AND PASSENGERS OF RECREATIONAL AVIATION AIRCRAFT, BY PARTICIPATION, ACCEPT THE RISKS INHERENT IN SUCH PARTICIPATION OF WHICH THE ORDINARY PRUDENT PERSON IS OR SHOULD BE AWARE. PILOTS AND PASSENGERS HAVE A DUTY TO EXERCISE GOOD JUDGMENT AND TO OBEY ALL ORAL OR WRITTEN WARNINGS, OR BOTH, PRIOR TO OR DURING USE OF THE AIRCRAFT, OR BOTH.

THE OWNER AND OPERATOR MUST UNDERSTAND THAT DUE TO THE INHERENT RISK INVOLVED IN FLYING A MICROLIGHT/ULTRALIGHT/TRIKE/POWERED HANG GLIDER, NO WARRANTY IS MADE OR IMPLIED, OF ANY KIND, AGAINST ACCIDENTS, BODILY INJURY OR DEATH OTHER THAN THOSE, WHICH CANNOT BY LAW BE EXCLUDED.

THE SAFE OPERATION OF THIS AIRCRAFT RESTS WITH YOU, THE PILOT.

WE BELIEVE THAT IN ORDER TO FLY SAFELY YOU MUST MATURELY PRACTICE AIRMANSHIP.

OPERATIONS OUTSIDE THE RECOMMENDED FLIGHT ENVELOPE SUCH AS AEROBATIC MANOEUVRES OR ERRATIC PILOT TECHNIQUE MAY ULTIMATELY PRODUCE EQUIPMENT FAILURE. YOU ARE REFERRED TO THE OPERATING LIMITATIONS IN SECTION 2 OF THIS MANUAL

THE SETTING UP AND BREAKING DOWN OF A MICROLIGHT/ULTRALIGHT/TRIKE/POWERED HANG GLIDER, TRANSPORTATION AND FLYING WILL HAVE AN EFFECT OVER TIME ON ITS STRUCTURAL INTEGRITY.

THE AIRCRAFT WILL REQUIRE MAINTENANCE AS OUTLINED IN THE APPLICABLE MAINTENANCE MANUALS.

LIKE ANY AIRCRAFT, SAFETY DEPENDS ON A COMBINATION OF CAREFUL MAINTENANCE AND YOUR ABILITY TO FLY INTELLIGENTLY AND CONSERVATIVELY.

WE HOPE THAT YOUR AIRCRAFT WILL PROVIDE YOU WITH MANY HOURS OF SAFE AND ENJOYABLE FLYING.

1.1.2 Definitions

Definitions used in these Aircraft Operating Instructions such as **WARNING**, **CAUTION** and **NOTE** are employed in the following context.

WARNING

OPERATING PROCEDURES, TECHNIQUES, ETC. WHICH IF NOT FOLLOWED CORRECTLY, MAY RESULT IN PERSONAL INJURY OR DEATH.

CAUTION

OPERATING PROCEDURES, TECHNIQUES, ETC. WHICH IF NOT STRICTLY OBSERVED, MAY RESULT IN DAMAGE TO THE AIRCRAFT OR ITS INSTALLED EQUIPMENT.

NOTE

Operating procedures, techniques, etc. which it is considered essential to highlight.

1.2 General Description

1.1.3 Two View Photos



Figure 1 Section 1. Aircraft Front View



Figure 2 Section 1. Aircraft Side View

1.1.4 General Dimensions

1.1.4.1 XT 582 / Cruze

DIMENSIONS	Australian	European	USA
Wing Span	9.97 m	9.97 m	32.7 ft
Wing Area	14.4 sq m	14.4 sq m	155 sq ft
Aspect Ratio	6.9		
Wing Weight	51 kg	51 kg	112 lbs
Overall Height (Control Bar Fwd)	3.65 m	3.65 m	11.9 ft
Trike Width	1.91 m	1.91 m	6.3 ft
Trike Length	2.85 m	2.85 m	9.3 ft
Wheel Track	1.7 m	1.7 m	5.6 ft
Wheel Base	1.89 m	1.89 m	6.2 ft
Trike Height	2.53 m	2.53 m	8.3 ft
Cockpit Width	0.7 m	0.7 m	2.3 ft
Wing (Packed) Length	5.6 m	5.6 m	18.4 ft
Wing Length (Short Packed)	4.2 m	4.2 m	13.8 ft

XT 582 Outback / Cruze

DIMENSIONS	Australian	European	USA
Trike Length	2.76 m	2.76 m	9.1 ft
Height Trike Base (propeller)	1.62 m	1.62 m	5.3 ft
Height Minimum Trike Base	1.450 m	1.450 m	4.8 ft
Overall Height (Control Bar Fwd)	3.85 m	3.85 m	12.6 ft

Table 1 Section 1. General Dimensions

1.1.5 General Description

1.1.5.1 Base

Full Cockpit Model

The XT 582 trike base is a two seat (in-line) weight shift controlled aircraft. A Rotax 582 two-stroke engine producing 65 HP powers the base. The layout is typical of this class of two seat trike design, with the pilot passenger “pod” being suspended by a triangular frame, hinged from the mast head about the pitch and roll axes, to provide for weight shift control.

The cockpit has a tall windscreen for improved wind deflection and is cut away at the sides to allow for easier pilot access. The wide rear 6-inch wheels remain a feature of the XT base but the wheel pants/spats have been redesigned and include integrated aerodynamic fins to improve base yaw stability.

Binnacle Tundra Model

The XT Outback has a spacious instrument housing with windscreen for the comfort of the pilot. The reduced lateral area of the instrument housing and windscreen with the absence of cockpit allows the use of large open wheels with no fins and tundra tyres for use on unprepared ground.

1.1.5.2 Wing

The Cruze wing is the result of continued refinement of AirBorne trike wings. The wings are fairly typical of an established class of swept, tapered, flexible fabric wings with enclosed crossbars and a relatively high aspect ratio.

The Cruze sail has several cloth and velcro shear ribs, which combined with an excellent sail “fit”, produces a wing that has light handling with impressive “feel” in turbulence. The battens ends are a unique design, which can be adjusted to vary tension for tuning the wing. The batten mechanism allows easy installation and removal of the battens.

An airfoiled aluminium section is used for the down tubes and king post. Clever engineering features fittings that look smart and are positioned to achieve minimum drag.

1.1.5.3 XT 582 Cruze

The Cruze wing was developed as an intermediate wing with lower stall speed and lower top speed. Additional sail area has been added to the tip of the wing with a reduction in the sail luff curve. The result of the XT 582 coupled with the Cruze is a very stable wing with a “softer” feel than that of the Streak wing. The Cruze wing is a good all round wing with lower top speed than the Streak 3. The stall speed is also lower with shorter take off and landing distance required.

1.2 Symbols Abbreviations and Terminology

In these Aircraft Operating Instructions:

“**AOI**” means Aircraft Operating Instructions

“**Airfield Pressure Altitude or QNE**” means the altitude of the airfield as indicated on an altimeter with the subscale adjusted to 1013.2 millibars or hectopascals.

“**AUW**” (**All Up Weight**) means the weight of the aircraft including occupants, fuel quantity, engine fluids, and removable and disposable equipment.

“**CG**” means the Centre of Gravity.

“**Empty Weight**” Refer to the note at Section 6.2 for the defined empty weight.

“**FAA**” United States Federal Aviation Administration

“**fpm**” means feet per minute.

“**HGFA**” means the Hang Gliding Federation of Australia.

“**KCAS**” means Knots Calibrated Airspeed

“**KIAS**” means Knots Indicated Airspeed as displayed on the cockpit mounted airspeed indicator.

“**kg**” means weight in kilograms.

“**Landing Approach Speed**” means the airspeed that allows control in turbulence, wind gradient or sudden engine failure during landing.

“**Manoeuvring Speed**” means the indicated airspeed above which the pilot may not make full or abrupt control movements.

“**QNH**” – means the pressure setting, that if set on the subscale of a sensitive altimeter, will cause the altimeter to indicate the correct local altitude above mean sea level.

“**RAA**” means the Recreational Aviation Australia.

“**Stall Speed**” means the indicated airspeed at which an uncontrolled downward pitching motion of the aircraft occurs or the forward control bar limit is reached.

“**Take Off Safety Speed**” means the airspeed that allows control in turbulence, wind gradient or sudden engine failure during the climb following take-off.

“**Trim Speed**” means the indicated airspeed at which the aircraft remains in a stabilised condition without pilot input.

“**V_d**” means the aircraft design diving speed.

“**V_h**” means maximum level speed.

“**V_{NE}**” means the indicated airspeed that the aircraft is never to exceed.

1.3 Use of metric / imperial units

This AOI uses the metric unit system as the basic system of measurement. Where common usage or available instrumentation refer to the Imperial system both units are quoted. The following conversion factors are presented as a ready reference to the conversion factors that have been used in this manual.

1 Pound (lb)	=	0.4536 Kilogram (kg)
1 Pound per sq inch (psi)	=	6.895 Kilopascal (kPa)
1 Inch (in)	=	25.4 Millimetres (mm)
1 Foot (ft)	=	0.3048 Metre (m)
1 Statute mile	=	1.609 Kilometres (km)
1 Nautical mile (NM)	=	1.852 Kilometres (km)
1 Millibar (mb)	=	1 Hectopascal (hPa)
1 Millibar (mb)	=	0.1 Kilopascal (kPa)
1 Imperial gallon	=	4.546 Litres (l)
1 US gallon	=	3.785 Litres (l)
1 US quart	=	0.946 Litre (l)
1 Cubic foot (ft ³)	=	28.317 Litres (l)
1 Degree Fahrenheit (F)	=	(1.8 X C)+32
1 Inch Pound (in lb)	=	0.113 Newton Metres (Nm)
1 Foot Pound (ft lb)	=	1.356 Newton Metres (Nm)

Table 1 Section 1. Metric/Imperial Conversion Factors

LIMITATIONS

LIMITATIONS	1
2 LIMITATIONS	3
2.1 General	3
2.2 Airspeed Limitations	3
2.3 Airspeed Indicator markings	3
2.4 Power Plant Limitations	3
2.4.1 Engine	3
2.4.2 Engine Limitations	4
2.4.3 Fuel Grades	4
2.4.4 Engine Lubricating Oil	5
2.4.5 Rotary Valve Lubrication	5
2.4.6 Gearbox Lubrication	5
2.4.7 Cooling System	5
2.4.8 Propeller	6
2.4.9 Engine Instrument Markings	6
2.5 Weight limits	6
2.6 Operational Limits	7
2.6.1 Centre of Gravity limits	7
2.6.2 Manoeuvring Limits	7
2.6.3 Bank Angle	7
2.6.4 Flight Load Factor Limits	7
2.6.5 Flight Crew Limits	7
2.6.6 Kinds of Operation Limits	7
2.6.7 Fuel Limitations	8
2.6.8 Maximum Passenger Seating Limits	8
2.6.9 Minimum Pilot Weight	8
2.6.10 Other Limitations	8
2.7 Placards	9
2.7.1 Flight Limitations Placard	9
2.7.2 Dash Placard Locations	10
2.7.3 Aircraft Operating Instructions Placard	10
2.7.4 Wing V_{ne} ASI Placard	11
2.7.5 Cruze Wing Trimmer Operation Placard	11
2.7.6 Trimmer Placard Location	12
2.7.7 Fuel Capacity Placard	13
2.7.8 Fuel Tap Placard	13
2.7.9 Hand Throttle and Ignition Placard	13
2.7.10 Pilots Right Seat frame Placard	14
2.7.11 Choke Placard	14
2.7.12 Mast Block Placard Locations	15
2.7.13 Pilots Left Seat frame Placards	15
2.7.14 Earth Placard	16
2.7.15 Circuit Breaker and Power Socket Placard	16
2.7.16 Oil Tank Capacity Placard	17
2.7.17 No Step Placard	17
2.7.18 Step Placard	18
2.7.19 Step and No Step Placards	18
2.7.20 Clear Prop Placard	19
2.7.21 Shock Absorber Pressure Placard	19

2.7.22	Right Hand Suspension Strut Placards _____	19
2.7.23	King Post Placard _____	20
2.7.24	Wing and Base Data Plates _____	20
2.7.25	Emergency Parachute _____	21
2.7.26	Emergency Parachute Placard Location _____	21
2.7.27	Emergency Parachute Warning Placard _____	22
2.7.28	Under Seat Placard _____	22

2 LIMITATIONS

2.1 General

The limitations section of this AOI outlines the various operating limitations, instrument function and placards necessary for the safe operation of this aircraft, engine and standard equipment.

2.2 Airspeed Limitations

2.2.0.1 XT 582 Cruze

Speed	KIAS	KCAS	Comments
Never Exceed Speed (V_{ne})	73 knots	65 knots	Do not exceed this speed in any operation
Maximum Manoeuvring Speed (V_a)	73 knots	65 knots	Do not make full or abrupt control movements above this speed

Table 1 Section 2. Airspeed Limitations

2.3 Airspeed Indicator markings

The standard pressure airspeed indicator on the left side of the dash has dual red radial markings indicating V_{ne} for the Streak 3 and Cruze wings. The pilot should be aware of the combination of wing and base and be familiar with the appropriate V_{ne} marking

2.4 Power Plant Limitations

2.4.1 Engine

Manufacturer: Rotax Bombardier
Model: Rotax 582 UL DCDI / mod 99 (2 Stroke)
Gearbox ratio: 3.47: 1

2.4.2 Engine Limitations

ENGINE LIMITATIONS	Metric	Imperial
ENGINE SPEED		
Take Off (Max 5 mins)	6800 rpm	6800 rpm
Maximum Continuous	6500 rpm	6500 rpm
PERFORMANCE		
Performance @ 6500rpm	48 kW	64.4 hp
COOLANT TEMPERATURE		
Maximum	80 deg C	175 deg F
Minimum	65 deg C	150 deg F
CYLINDER HEAD TEMPERATURE		
Maximum	150 deg C	300 deg F
Minimum	110 deg C	230 deg F
EXHAUST GAS TEMPERATURE		
Maximum	650 Deg C	1200 deg F
Maximum	500 Deg C	930 deg F
AMBIENT START & OPERATING TEMPERATURE		
Maximum	44 deg C	111 deg F
Minimum	-25 deg C	13 deg F

Table 2 Section 2. Engine Limitations

2.4.3 Fuel Grades

FUEL	
Preferred Fuel Type	En228 Premium/Regular. Super grade gasoline, lead free, min RON 90
Optional Fuel Type	AVGAS (see note)

Table 3 Section 2. Fuel Specification

NOTE

Due to higher lead content in AVGAS deposits in the combustion chamber will increase. Therefore, use AVGAS only if you encounter problems with vapour lock or if the other fuel type is not available.

Use of AVGAS requires higher frequency maintenance intervals. Refer to the maintenance manual.

Refer to section 2.6.7 for fuel capacities and limitations

2.4.4 Engine Lubricating Oil

Engine lubrication is supplied via the oil injection system which is gravity fed. The oil quantity is defined by engine rpm and the lever position. The lever is actuated via a Bowden cable connected to the throttle cable. The oil injection tank has a capacity of 2 litres.

Oil Specifications

Oil used is Super two stroke ASTM/CEC standards, API-TC classification (consult your Rotax dealer for a recommended oil to suit your operating environment).

2.4.5 Rotary Valve Lubrication

Rotary valve lubrication is supplied via a small tank mounted on the top right hand side of the engine. The tank has a maximum fill level with a capacity of 60 mL of oil. The oil has the same specifications as the oil injection system.

Oil Specifications

Oil used is Super two stroke ASTM/CEC standards, API-TC classification (consult your Rotax dealer for a recommended oil to suit your operating environment).

2.4.6 Gearbox Lubrication

The gearbox on the XT 582 is inverted and in this configuration requires 400 mL of oil. See maintenance manual for further details.

Oil Specifications

Gear oil API-GL5 or GL6, SAE 140 EP or 85W – 140 EP

2.4.7 Cooling System

WARNING

DO NOT OPEN THE COOLING SYSTEM WHEN THE ENGINE IS HOT. SEVERE SCALDING AND OTHER INJURIES MAY RESULT.

Water-cooling system capacity is 4.0L. See maintenance manual for further details.

Coolant Specification

Rotax specifies use of: 50% antifreeze concentrate with additives against corrosion and 50% pure water, or use of an equivalent premixed coolant.

AirBorne has had satisfactory results using the brand Nulon Red which is silicate free and is a Mono Ethylene Glycol product containing 1040 gm glycol per litre.

2.4.8 Propeller

- Manufacturer:** Bolly Propellers
Model: BOS3 68 x 58 SR 3B
Type: 3 Blade Composite ground adjustable
Diameter: 1727mm +/- 5mm
Pitch: Standard pitch is an angle of 19 +/- 0.5 degrees, at a radius of 24 inches.

The maximum propeller speed of 1960 RPM has been determined by test. The maximum propeller speed occurs when the engine RPM reaches 6800 RPM.

2.4.9 Engine Instrument Markings

The GX2 instrument has preset alarm limit thresholds. If any of these temperature or pressure limitations are reached the red light on the instrument panel will start to flash. Limitations can be found in section 2.4.2. A low level oil condition will also cause the alarm to be activated (see section 4.7).

2.5 Weight limits

	Metric	Imperial
Max take off weight	450 kg	992 lb
Typical empty weight *	212 kg	467 lb
Maximum empty weight *	257 kg	567 lb
Permitted range of pilot weights (Front seat)	55-100 kg	121-220 lb
(Rear seat)	0-100 kg	0-220 lb
Total maximum crew weight	200 kg	440 lb
Maximum under seat storage load per bag	2kg	4 lb

Table 4 Section 2. Weight Limits

* Includes 3 litres (2kg) unusable fuel. Empty weight is defined in section 6.2.

2.6 Operational Limits

2.6.1 Centre of Gravity limits

Centre of gravity limits are not critical on the base of a flex wing microlight. Having the trike unit attached to the wing from a single universal bracket, variations of cockpit loading and fuel loading cannot influence the aircraft's balance. The Edge XT is therefore not critical in regards to centre of gravity although the distribution of load in the trike base has a minor affect on the in-flight attitude of the trike base.

Base Suspension Range (Measured from the line joining the leading edge nose bolts to the suspension point.)	Dimension
CRUZE WING	1245 mm +/- 15mm

Table 5 Section 2. Centre of Gravity Limits

NOTE

The rear hole on the wing suspension bracket on the Cruze wing has been blanked off so that it cannot be used. Using the rear hole was found to show non-compliance to the minimum required trim speed of 1.3 V_S.

2.6.2 Manoeuvring Limits

All aerobatic manoeuvres including spinning is prohibited.

Aerobatic manoeuvres including whipstalls, stalled spiral descents and negative "G" manoeuvres are not permitted. It must be emphasised that a whipstall, spiral descent or negative G manoeuvre can never be conducted safely. These manoeuvres put the aircraft outside the pilots control and put both the aircraft and its occupants in extreme danger.

Do not pitch nose up or nose down more than 45 degrees from the horizontal. The front support tube of the trike and the pilot's chest limits the fore and aft movement of the control bar respectively.

2.6.3 Bank Angle

Do not exceed 60 degrees of bank angle. In roll there is no stop for the control movement. For the purpose of pre-flight freedom, check by lowering each wing to within 10 cm of the ground (on ground level).

2.6.4 Flight Load Factor Limits

Max positive manoeuvring load factor	4.0 G
Negative load factors	Prohibited
Load factors below 1.0 G	To be avoided

Table 6 Section 2. Flight Load Factor Limits

2.6.5 Flight Crew Limits

Minimum flight crew is 1 person (Front Seat)

2.6.6 Kinds of Operation Limits

The aircraft is only to be flown under visual flight rules (VFR), and the minimum equipment required to operate under VFR conditions are an air speed indicator, altimeter and instruments required by the engine manufacturer.

In Australia, when operated at a public aerodrome or on a cross country flight, a compass and reliable time piece are required. Additional equipment may be required for some overseas operations.

2.6.7 Fuel Limitations

Maximum Usable Fuel	67 litre	17.7 US Gal
Unusable Fuel capacity	3 litre	0.8 US Gal
Sump Capacity	500 mL	0.13 US Gal

Table 7 Section 2. Fuel Limitations

CAUTION
SIGHT GAUGE 10 LITRE GRADUATIONS INDICATE TOTAL FUEL, NOT USABLE FUEL. ZERO USABLE FUEL IS INDICATED WHEN THE FUEL IS LEVEL WITH THE BOTTOM OF THE SIGHT GAUGE

2.6.8 Maximum Passenger Seating Limits

One passenger maximum allowed.

2.6.9 Minimum Pilot Weight

The microlight aircraft must only be flown solo from the front seat. Minimum pilot weight flown solo shall not be below 55 kg. Maximum power at minimum TOW can cause an abrupt climb rate that, if uncorrected, may cause a wing attitude of greater than the placarded maximum of 45 degrees. Approximately 2/3 of maximum take off power is considered comfortable for a minimum weight takeoff. Take off distance will be extended at reduced power.

2.6.10 Other Limitations

Maximum Cross Wind	12 knots	13 mph
Maximum Wind Strength	20 knots	23 mph
Maximum Ambient Operating Temperature	47 deg C	116 deg F

Table 8 Section2. Other Limitations

No person who is untrained or unqualified in weight shift controlled flight or, who is unfamiliar with the wing and base combination, should ever attempt to pilot the aircraft unless under professional instruction.

The effect of light rain on the aircraft can increase the stall speed. It is extremely important to maintain speeds in excess of the take off and landing safety speeds when the wing is wet. If the aircraft has been left out in the rain or heavy dew it is necessary to wipe the wing down prior to take off. It is also recommended that the aircraft be flown solo first to ensure all excess moisture is removed. A chamois or sponge is recommended to remove the water.

Continued operation in heavy rain is not recommended due to the abrasive effect of raindrops on the propeller. Do not use waterproofing agents on the wing as the consequent beading of water droplets can significantly increase the stall speed.

CAUTION
MOISTURE ON THE WING CAN INCREASE STALL SPEED AND SHOULD BE REMOVED PRIOR TO TAKE OFF.

The XT 582 has a pull start mechanism on the front of the engine. The pull start should not be used for in flight starting. The pull start is intended as a back up in the case of a low battery and should only be operated when the aircraft is on the ground with the park brake activated.

2.7 Placards

The placards on the aircraft are designed to provide information regarding general aircraft limitations and other details for the safe operation of the aircraft. Listed on the following pages are details of the placards fitted to the aircraft.

2.7.1 Flight Limitations Placard

62mm

ROTAX 582 UL ENGINE LIMITATIONS		
	MIN	MAX
ENGINE RPM		6800 rpm
WATER TEMPERATURE	150 Deg F	175 Deg F
EXHAUST GAS TEMPERATURE	930 Deg F	1200 Deg F
CYLINDER HEAD TEMPERATURE	230 Deg F	300 Deg F
FUEL TANK CAPACITY		18.5 USGal
USEABLE FUEL		17.7 USGal
LOADING LIMITATIONS - SEE AIRCRAFT OPERATING INSTRUCTIONS SECT 6.3.4 FOR FUEL LOAD LIMITATIONS.		
EMPTY WEIGHT		
MAX TAKEOFF WEIGHT		
WEIGHT OF OCCUPANTS	MIN 121lbs	MAX 440lbs
FLY SOLO FROM FRONT SEAT ONLY		

72mm

PART No.107601
 PLACARD ENGINE LIMITS
 XT582 LSA IMPERIAL

62mm

ROTAX 582 UL ENGINE LIMITATIONS		
	MIN	MAX
ENGINE RPM		6800 rpm
WATER TEMPERATURE	65 Deg C	80 DegC
EXHAUST GAS TEMPERATURE	500 Deg C	650 Deg C
CYLINDER HEAD TEMPERATURE	110 Deg C	150 Deg C
FUEL TANK CAPACITY		70 Litres
USEABLE FUEL		67 Litres
LOADING LIMITATIONS - SEE AIRCRAFT OPERATING INSTRUCTIONS SECT 6.3.3 FOR FUEL LOAD LIMITATIONS.		
EMPTY WEIGHT		
MAX TAKEOFF WEIGHT		
WEIGHT OF OCCUPANTS	MIN 55kg	MAX 200kg
FLY SOLO FROM FRONT SEAT ONLY		

72mm

PART No.107602
 PLACARD ENGINE LIMITS
 XT582 LSA METRIC

62mm

AIRBORNE WINDSPORTS Pty. Ltd. Newcastle, NSW, Australia www.airborne.com.au	
AIRCRAFT TYPE	EDGE XT
FLIGHT LIMITATIONS	
DO NOT PITCH NOSE DOWN OR NOSE UP MORE THAN 45 DEGREES FROM HORIZONTAL. DO NOT EXCEED 60 DEGREES OF BANK. NO NEGATIVE G. NO AEROBATIC MANOEUVRES. NO INTENTIONAL SPINS. NO WHIPSTALLS. NO STALLED SPIRAL DESCENTS. APPROVED FOR DAY VISUAL METEOROLOGICAL CONDITIONS ONLY.	
WARNINGS	
NO SMOKING. ALWAYS PREFLIGHT AIRCRAFT. ENSURE MAST LOCKED IN POSITION BEFORE STARTING ENGINE. OPERATE IN ACCORDANCE WITH LIMITATIONS AND PROCEDURES DETAILED IN THE AIRCRAFT OPERATING INSTRUCTIONS.	

72mm

PART No.107596

Location	The flight limitation placards are located on the dash either side of the mast brace. Engine limitations placard option of metric 107602 or imperial 107601
Series	Edge XT Series

Table 9 Section 2. Flight Limitations Placards

2.7.2 Dash Placard Locations



Figure 1 Section 2. Flight Limitations, Airspeed, Circuit Breaker, Power Socket and Aircraft Operating Instructions Placard Locations

2.7.3 Aircraft Operating Instructions Placard



Figure 2 Aircraft Operating Instructions Placard Part # 107592

Location	The Aircraft Operating Instructions placard is located on the trike dash below the GX2 Instrument
-----------------	---

Series Edge XT Series

Table 10 Section 2. Hand Book Placard

2.7.4 Wing V_{ne} ASI Placard

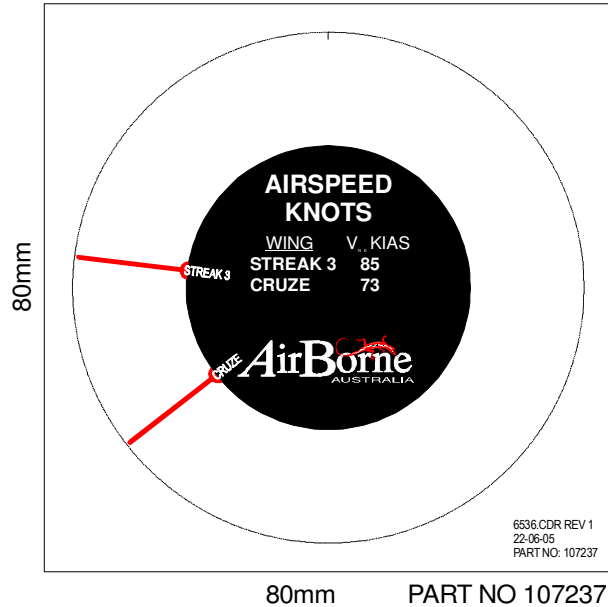

Location The V_{ne} Placard is located on the air speed indicator on the left side of dash.

Series Edge XT Series

Table 11 Section 2. Wing V_{ne} ASI Placard

2.7.5 Cruze Wing Trimmer Operation Placard

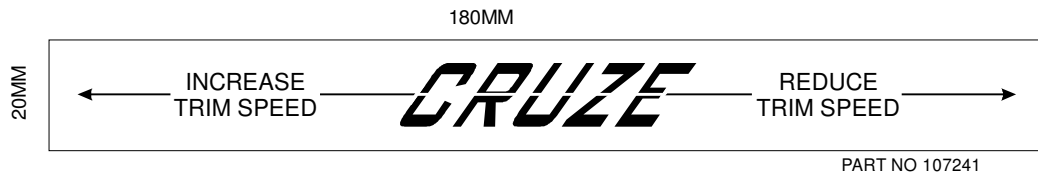

Location The wing trimmer operation placard is located on the right side control frame down tube adjacent to the trimmer knob. The placard is installed so that the “Increase trim speed” arrow faces downward on the down tube.

Series Cruze

Table 12 Section 2. Wing Trimmer Operation Placard

2.7.6 Trimmer Placard Location

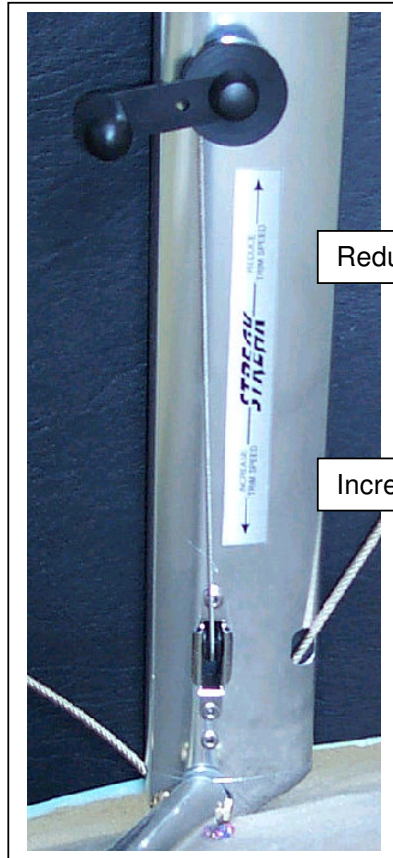

Reduce Trim Speed

Increase Trim

NOTE

Ensure that the placard is the correct orientation, as shown by the text boxes beside the photograph (Streak placard shown in photo).

Figure 2 Section 2. Trimmer Placard Location

2.7.7 Fuel Capacity Placard

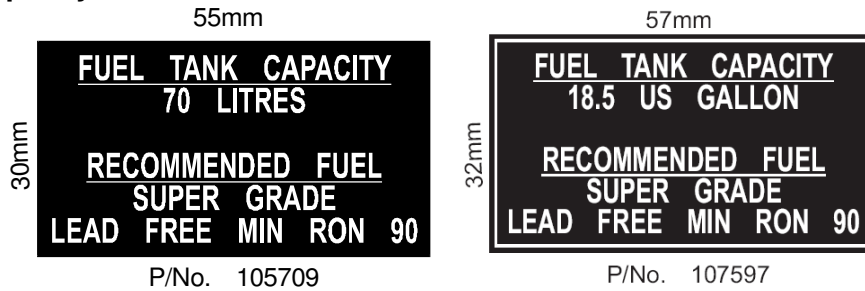

Location	The fuel capacity placard is located on the right side shock absorber.
Series	Edge XT Series

Table 13 Section 2. Fuel Capacity Placard

2.7.8 Fuel Tap Placard

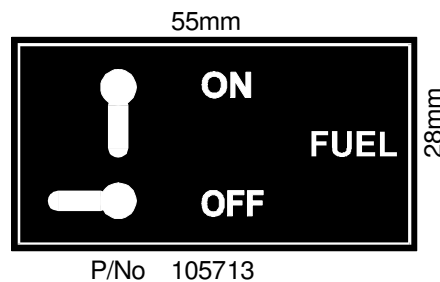

Location	The fuel tap placard is adjacent to the fuel tap on seat mast block on the left side of the aircraft.
Series	Edge XT Series

Table 14 Section 2. Fuel Tap Placard

2.7.9 Hand Throttle and Ignition Placard

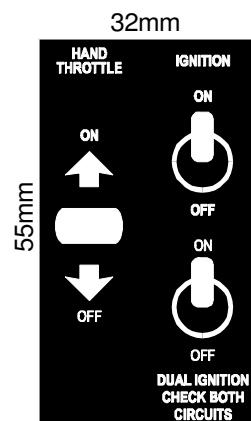

Location	The hand throttle placard is located on the right side seat frame adjacent to the hand throttle lever.
Series	Edge XT Series

Table 1 Section 2. Hand Throttle and Ignition Placard

2.7.10 Pilots Right Seat frame Placard

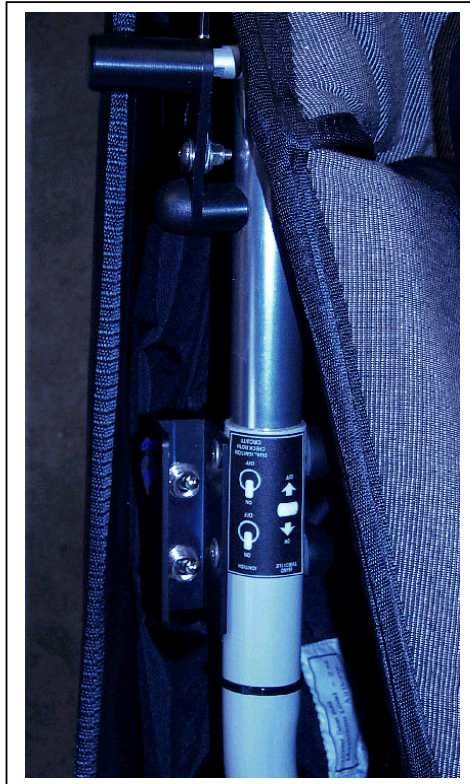
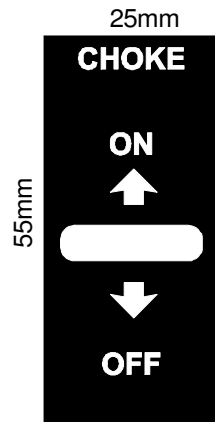

Figure 3 Section 2. Hand Throttle and Ignition Placard

2.7.11 Choke Placard



PART No.105711

Location	The hand choke placard is located on the left side seat frame adjacent to the hand choke lever.
Series	Edge XT Series

Table 16 Section 2. Choke Placard

2.7.12 Mast Block Placard Locations

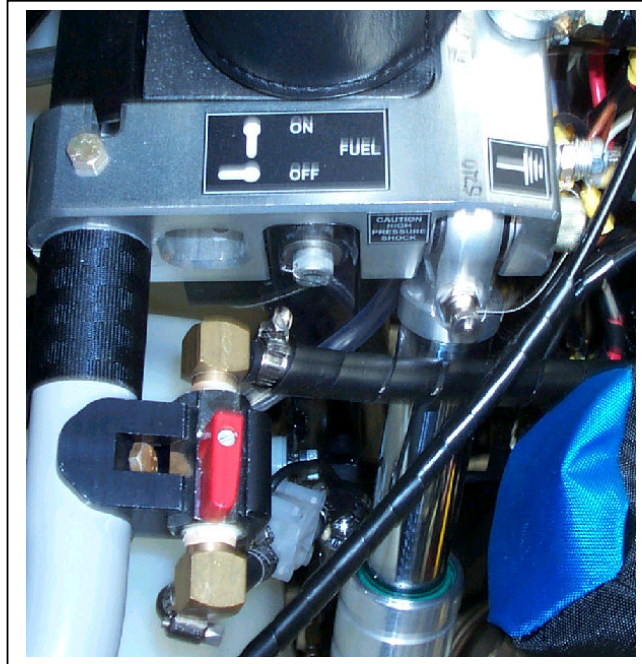

Figure 4 Section 2. Fuel Tap, Shock Absorber Pressure and Earth Placard Locations

2.7.13 Pilots Left Seat frame Placards

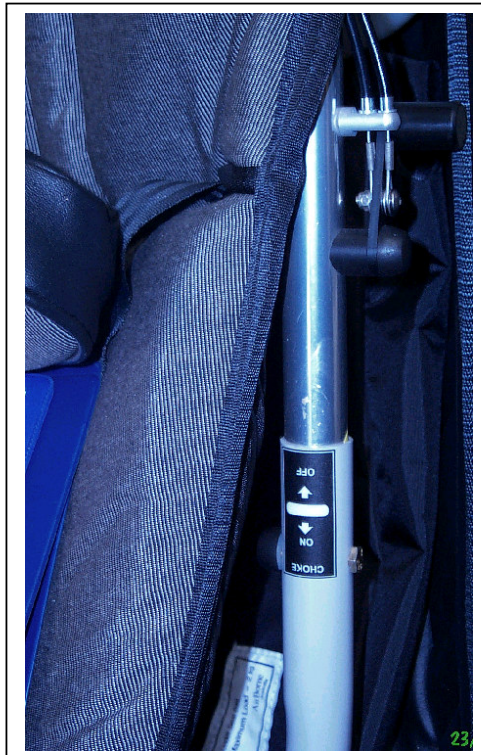
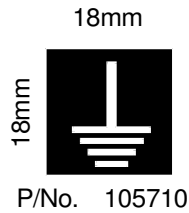

Figure 5 Section 2. Choke Placard Location (Under Seat Bag Placard in Background)

2.7.14 Earth Placard



Location	The engine earth placard is located on the rear of the seat mast block on the left side.
Series	Edge XT Series

Table 17 Section 2. Earth Placard

2.7.15 Circuit Breaker and Power Socket Placard

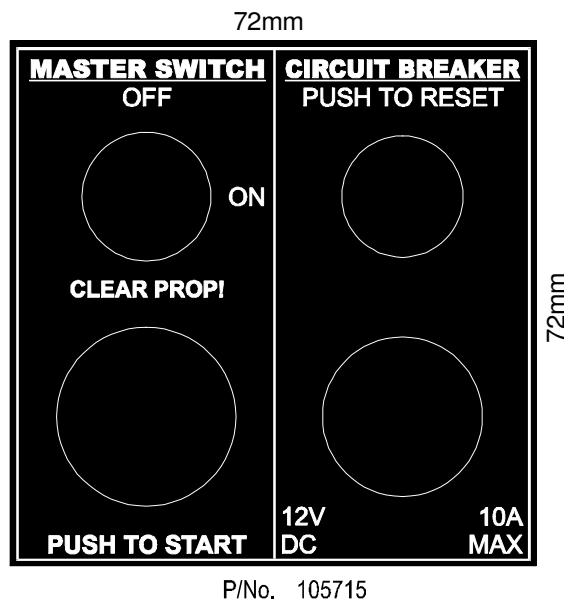

Location	The master switch / circuit breaker placard is located on the right side dash.
Series	Edge XT Series

Table 18 Section 2. Circuit Breaker and Power Socket Placard

2.7.16 Oil Tank Capacity Placard



Location	The oil tank capacity placard is located on the oil tank on the top left side of the engine.
Series	Edge XT582 Series

Table 19 Section 2. Tank Oil Capacity Placard

2.7.17 No Step Placard

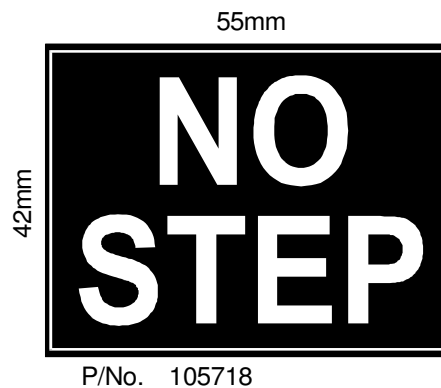

Location	The no step placards are located on the floor of the cockpit, either side of the base tube.
Series	Edge XT Series

Table 20 Section 2. No Step Placard

2.7.18 Step Placard



Location	The step placard is on the trike base tube at the hinge point for the rear foot rest.
Series	Edge XT Series

Table 21 Section 2. Step Placard

2.7.19 Step and No Step Placards



Figure 6 Section 2. Step and No Step Placards

NOTE

There is a symmetrical no step placard on the other side of the pod.

2.7.20 Clear Prop Placard



Location	The clear prop placard is located on the right and left side compression struts.
Series	Edge XT Series

Table 22 Section 2. Clear Prop Placard

2.7.21 Shock Absorber Pressure Placard

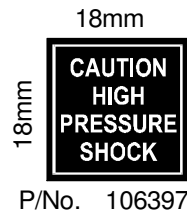

Location	The shock placard is located on the main block near the top of the shock.
Series	Edge XT Series

Table 23 Section 2. Shock Absorber Pressure Placard

2.7.22 Right Hand Suspension Strut Placards



Figure 7 Section 2. Clear Prop and Fuel Spec Placards

2.7.23 King Post Placard

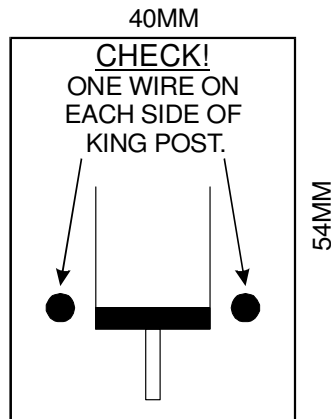

PART NO 104622

Location	The king post placard is located on the rear of the keel tube of the wing.
Series	All Wings

Table 24 Section 2. King Post Placard

2.7.24 Wing and Base Data Plates



Part Number 107563



Part Number 107567

Location	The wing data plate is located on the negative block of the universal bracket. The base data plate is located on the seat mast block on the left side of the aircraft.
Series	XT base and applicable wing

Table 25 Section 2. Data Plates

2.7.25 Emergency Parachute

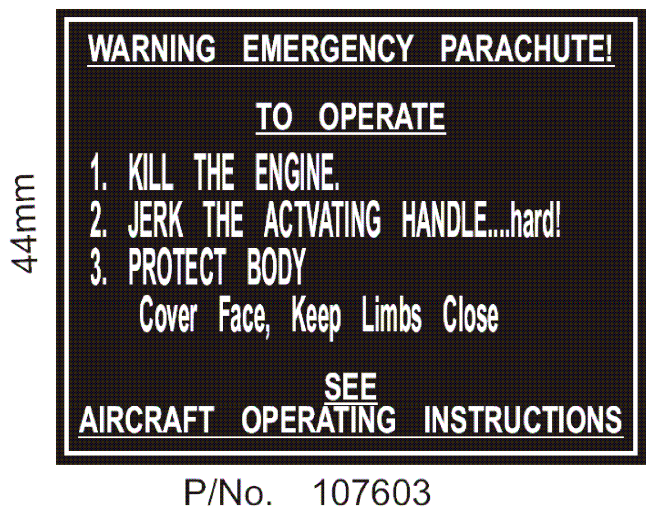

P/No. 107603

Location	The emergency parachute (when installed) placard is located on the inside left rear of the cockpit when the optional emergency parachute is fitted. When the Outback option is fitted the placard is located on base tube aft of instrument binnacle.
Series	Edge XT Series

Table 26 Section 2. Emergency Parachute

2.7.26 Emergency Parachute Placard Location

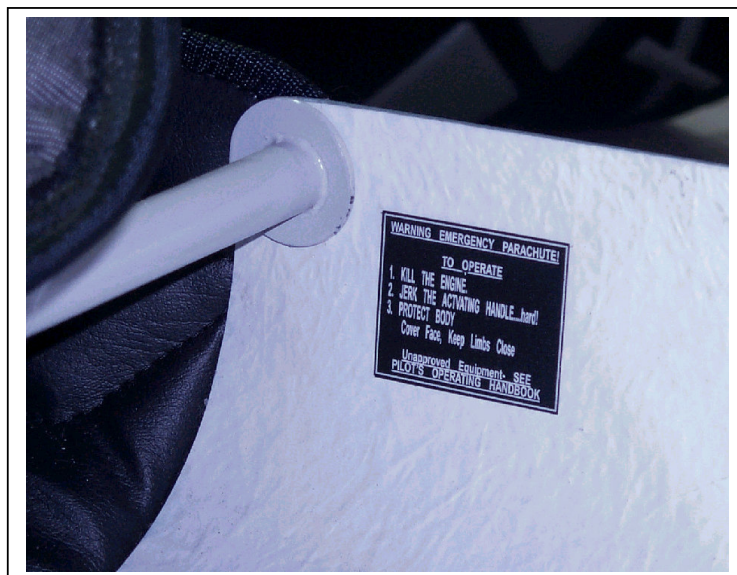
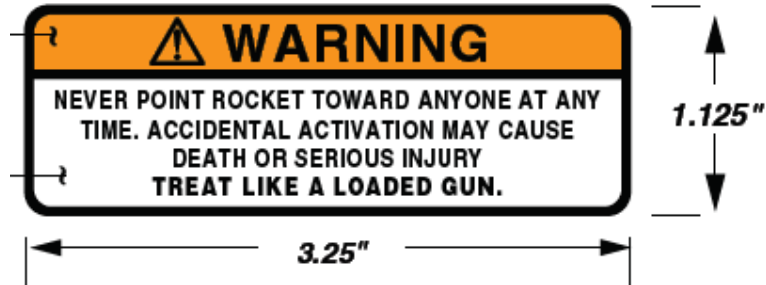

Figure 8 Section 2. Parachute Placard Location – (Pilots Left on Pod near to Seat Frame)

2.7.27 Emergency Parachute Warning Placard



Location	The emergency parachute warning placard is located on the parachute rocket at the rear of the aircraft.
Series	Edge XT Series (optional fitment)

Table 27 Emergency Parachute Warning

2.7.28 Under Seat Placard



Location	The under seat placard is located under the front seat, one placard per side beside the start of the zip.
Series	Edge XT Series

Table 28 Section 2. Under Seat Placard

EMERGENCY PROCEDURES

EMERGENCY PROCEDURES	1
3 EMERGENCY PROCEDURES	2
3.1 General	2
3.2 Airspeeds for Emergency Operations	2
3.2.1 XT 582 / Cruze	2
3.3 Emergency Procedures Check List	3
3.3.1 Engine Failure on Climb Out	3
3.3.2 Engine Failure at Height	3
3.3.3 Full Power Engine Shutdown (In Flight)	3
3.3.4 Forced Landings	3
3.3.5 In Air Engine Fire	4
3.3.6 On Ground Engine Fire	5
3.3.7 Propeller Damage	5
3.3.8 Sail Damage	5
3.3.9 Emergency Parachute	5
3.3.10 Ignition Circuit Failure	6
3.3.11 Spins and Spiral Descents	6
3.3.12 Unusual Attitudes	6
3.3.13 Instrument Failure	7

3 EMERGENCY PROCEDURES

3.1 General

This section of the AOI describes the procedures to be adopted in the event of an emergency or abnormal situation occurring in this aircraft.

These procedures are arranged in the sequence considered to be the most desirable in the majority of cases. Steps should be performed in the order listed unless a suitable reason to deviate exists.

This section contains operating procedures for flight and system emergency conditions that are essential for the continued safe operation of the aircraft.

Always maintain correct airspeed and altitudes in the circuit area.

Never fly in uncertain weather conditions and always fly within your proven ability. Be sure only to extend your capabilities under planned training situations.

Carry out safe airmanship whilst flying and be aware of possible emergency landing areas along your flight path. If possible check these areas from the ground as you enter the airfield or flying site. This technique is for safety reasons as engines are susceptible to stopping, no matter how reliably manufactured or maintained.

Keep a good lookout for other aircraft, always be thoughtful and show your intentions. Demonstrate good airmanship always!

It should be remembered that the manufacturer cannot foresee all conceivable circumstances. Particular circumstances such as multiple or unanticipated emergencies, adverse weather etc. may require modification to these procedures. A thorough knowledge of the aircraft and its systems is required to analyze the situation correctly and to determine the best course of action.

3.2 Airspeeds for Emergency Operations

3.2.1 XT 582 / Cruze

Speed	IAS
Maximum Manoeuvring Speed (Va)	66 knots
Best Glide	45 knots

Table 1 Section 3. Airspeeds for Emergency Operations

3.3 Emergency Procedures Check List

3.3.1 Engine Failure on Climb Out

If your engine fails on climb out, maintain airspeed, reduce angle of attack and land straight ahead if possible. Proceed as follows:

- C** Maintain **C**ontrol
- A** Maintain **A**irspeed - take off safety speed
- L** Forced **L**anding (straight ahead if possible)

3.3.2 Engine Failure at Height

If the engine stops while operating at cruise or full power when the aircraft is well clear of the ground, check:

- C** Fuel **C**ontents
- F** Fuel tap on
- I** Ignition on

If your engine fails in flight, do not attempt to restart the engine unless one of these items is found to be incorrect and is able to be rectified. Relax and maintain control whilst concentrating on correct forced landing techniques.

3.3.3 Full Power Engine Shutdown (In Flight)

If the throttle should jam full open in flight proceed as follows:

- C** Maintain **C**ontrol.
- H** Get **H**eight. With engine at full power adjust height and ground position to improve the outcome of a forced landing.
- A** Increase **A**irspeed to keep the climb angle less than 30 degrees above the horizontal.
- I** Switch off **I**gnition.
- L** Prepare for forced **L**anding

3.3.4 Forced Landings

Proceed as follows:

- C** Maintain **C**ontrol and airspeed - nominated approach speed
- T** Throttle Closed
- I** Ignition off
- F** Fuel tap off
- S** Seat belts tight
- H** Helmets tight
- L** Limbs (arms and hands) inside seat frame
- L** Carry out final approach and **L**anding as closely as possible to normal power off landing procedure.

3.3.5 In Air Engine Fire

For fire occurring whilst in flight, the initial procedure would be to maintain control of the aircraft and evaluate the extent of the fire. This emergency is unlikely to occur but to avoid any further problems, use common sense and land the aircraft safely. Proceed as follows:

- C** Maintain **C**ontrol
- F** **F**uel tap off
- T** Full **T**hrottle (to exhaust engine system fuel as soon as possible and maximise slipstream to clear flames from passengers and airframe).

When fuel is exhausted then:

- I** **I**gnition off
- L** **F**orced **L**anding
- B** After landing release seat **B**elt
- P** Release **P**assenger seat belt
- E** **E**vacuate aircraft

3.3.6 On Ground Engine Fire

For fire occurring whilst in motion on the ground proceed as follows:

- C** Maintain **C**ontrol
- S** Use remaining **S**peed to clear people, aircraft and buildings
- T** Throttle closed
- I** Ignition Off
- B** After stopping release seat **B**elt
- P** Release **P**assenger seat belt
- F** Fuel tap off
- E** Evacuate aircraft

3.3.7 Propeller Damage

The indication of propeller damage is usually felt by extreme vibration and lack of thrust.

- C** Maintain **C**ontrol
- T** Throttle closed
- F** Fuel tap off
- I** Ignition off
- L** Forced **L**anding

WARNING
AT FULL ENGINE REVS THE TIP OF THE PROPELLER IS SPINNING AT SPEEDS IN EXCESS OF 650 KILOMETRES PER HOUR. EVEN SMALL OBJECTS CAN CAUSE SIGNIFICANT DAMAGE TO THE PROPELLER.

This problem may be avoided if precautions are taken prior to take off. Inspect the strip or ground you are to use as your take off area for sticks, rocks or any debris that may be flicked up by the tyres and sucked through the propeller.

Ensure that all items carried by occupants (such as cameras and sunglasses) are secured so they are not able to come loose and pass through the propeller.

3.3.8 Sail Damage

If you encounter damage to the sailcloth during flight, the first procedure is to maintain control of the aircraft. If the sail damage is not impairing the flight characteristics of the aircraft, land at the nearest landing field to inspect the damage.

3.3.9 Emergency Parachute

The emergency ballistic parachute can be fitted as an option.

The parachute-operating handle is fitted with a safety pin. This pin should be removed before each flight and the safety pin must be replaced before the pilot alights from the aircraft. A force of approximately 15 – 20 kg pull on the actuating handle is required to activate the BRS rocket motor.

The parachute is only to be used in emergency situations as a last resort and when you are certain that:

- the aircraft has suffered structural damage to the extent that control is not possible; or
- if the aircraft is in an irrecoverable situation where structural damage is likely to occur.

WARNING
IT IS IMPORTANT TO REALISE THAT WHILST THE PARACHUTE CONTROLS THE RATE OF DESCENT, THE PILOT WILL HAVE NO CONTROL OVER THE PLACE THE AIRCRAFT WILL “LAND”.

To operate the parachute pull the handle at least twenty centimetres for the parachute rocket projectile to be activated. The parachute will allow the complete aircraft to be lowered to the ground. The

aeroplane will descend with a steep nose down attitude and tilted to the left. Further information can be found in section 7.16.

Proceed as follows:

- T** Throttle closed
- I** Ignition off
- S** Seat belts tight
- P** Check parachute **P**in removed
- D** Deploy parachute
- L** Forced Landing

3.3.10 Ignition Circuit Failure

The Rotax engine requires a short circuit on the ignition circuit to stop the engine. If the ignition circuit is broken using full choke to flood the engine should stop the engine.

It is possible to starve the engine by switching the fuel tap off. This method is not as quick as using the chokes.

Do not restart the engine until the fault has been fixed.

3.3.11 Spins and Spiral Descents

Deliberate spinning is prohibited.

A spiral dive may develop after a stall if the bar is maintained at the forward limit and a large roll rate is allowed to develop. If this condition is not corrected it will lead to large and increasing roll attitudes (beyond the 60 degree limit). Increasing attitude, increasing speeds and large control bar feed back forces will occur. Incipient spiral dives can be terminated at any time by rolling wings level. If the spiral dive is allowed to develop to extreme roll attitudes, recovery is expedited by relieving control bar forces before rolling wings level and recovering from high-speed condition.

WARNING
DO NOT ATTEMPT TO SPIN THE AIRCRAFT.

SPIRAL DIVES SHOULD NOT BE ATTEMPTED.

DURING DESCENDING TURNS AIRCRAFT ATTITUDE MUST BE KEPT WITHIN PLACARDED PITCH, ROLL AND AIRSPEED LIMITS.

3.3.12 Unusual Attitudes

Unusual attitudes where the nose is raised or lowered more than 45 degrees from the horizontal are to be avoided. On recognising a situation where the aircraft is approaching these pitch angles proceed as outlined below.

3.3.12.1 Nose High Attitude

To recover from the situation where the nose of the aircraft is pitched up more than 45 degrees from the horizontal proceed as follows:

- H** Hold attitude - Do not attempt to pull control bar in
- P** Reduce **P**ower
- O** As energy dissipates the aircraft will rotate nose down - keep control bar **O**ut
- P** once the attitude lowers level the wings and increase **P**ower to prevent over pitching
- R** Recover from dive and **R**esume desired flight path

3.3.12.2 Nose Down Attitude

To recover from the situation where the nose of the aircraft is pitched down more than 45 degrees from the horizontal proceed as follows:

- O** Raise attitude - push **O**ut
- P** Apply **P**ower
- R** Recover from dive and **R**esume desired flight path

3.3.13 **Instrument Failure**

Instrument failure may occur through an electrical fault or through exposure to High Intensity Radio Fields (HIRF).

The aircraft is equipped with an analogue ASI as well as a digital engine management system. The analogue ASI will not be effected by either an electrical fault or HIRF. If there is a problem with the digital system the correct procedure is to fly to the nearest safe landing area and investigate the cause of the malfunction.

This page left blank intentionally

NORMAL PROCEDURES

NORMAL PROCEDURES	1
4 NORMAL PROCEDURES	3
4.1 General	3
4.1.1 XT 582 / Cruze Speeds for Normal Operation	3
4.1.2 Normal procedures Check List	3
4.2 Wing Assembly Procedure	3
4.2.1 Wing Assembly Procedure	3
4.2.2 Assemble Control Frame	4
4.2.3 Stand The Wing Up	5
4.2.4 Spread Leading Edges	5
4.2.5 Insert King Post	5
4.2.6 Insert Main Sail Battens	5
4.2.7 Tension Cross Bars	6
4.2.8 Install Pull Back Cover	6
4.2.9 Locate Nose Battens	7
4.2.10 Install Nose Fairing	7
4.2.11 Insert Remaining Main Sail Battens	7
4.2.12 Insert Undersurface Battens	7
4.2.13 Load Tip Strut	8
4.3 Wing Pre-flight inspection	9
4.4 Attaching Wing to Base	10
4.4.1 Attach Mast Retaining Strap	10
4.4.2 Position The Trike And Wing	11
4.4.3 Attach Mast To Wing U-Bracket	11
4.4.4 Position Heart Bolt Retainer in U-Bracket	11
4.4.5 Attach Back Up Loop	11
4.4.6 Remove Keel Extension	12
4.4.7 Rotate Wing	12
4.4.8 Insert Mast Lever	12
4.4.9 Attach Mast Brace	13
4.4.10 Load Mast Lever	13
4.4.11 Park The Aircraft	13
4.5 Complete Trike Pre-Flight Inspection	14
4.6 Fuelling	15
4.6.1 Fuel Tank Capacity	15
4.6.2 Fuel Quantity	15
4.7 Engine Lubricating Oil	15
4.8 Helmet Recommendation	16
4.9 Normal Procedures Check List	16
4.9.1 Before Starting Engine	17
4.9.2 Starting Engine	17
4.9.3 Before Take Off	18
4.9.4 Take Off and Initial Climb	18
4.9.5 Climb	18
4.9.6 Cruise Speeds	19
4.9.7 Descent	19
4.9.8 Landing	19

4.9.9	After Landing _____	19
4.10	Amplified Procedures _____	20
4.10.1	Before Starting _____	20
4.10.2	Starting the engine _____	20
4.10.3	Taxiing _____	21
4.10.4	Before take off _____	21
4.10.5	Take Off _____	22
4.10.6	Climb _____	22
4.10.7	Cruise _____	22
4.10.8	Stalls _____	23
4.10.9	Descent, Approach and Landing _____	23
4.10.10	Cross Wind Landing and Take Off _____	23
4.10.11	Baulked Landing _____	24
4.10.12	Stopping the Engine _____	24
4.11	After Landing / Securing _____	24
4.11.1	De-Rigging Procedure _____	24
4.12	Wing Break Down Procedure _____	25
4.12.1	Detension Tip Struts _____	25
4.12.2	Remove Tip Battens _____	25
4.12.3	Remove Undersurface Battens _____	25
4.12.4	Fit Tip Bags _____	26
4.12.5	Fit U-Bracket Cover _____	26
4.12.6	Velcro U-Bracket Face Cover _____	26
4.12.7	Trimmer Cover _____	27
4.12.8	Disconnect Nose Catch and Remove Nose Cone _____	27
4.12.9	Remove Sail Cowling _____	27
4.12.10	De-Tension Pull Back Cable _____	28
4.12.11	Remove Main Sail Battens _____	28
4.12.12	Remove King Post _____	28
4.12.13	Fold Leading Edges _____	29
4.12.14	Attach Straps _____	29
4.12.15	Fit Wing Bag _____	29
4.12.16	Roll Wing _____	29
4.12.17	Disconnect Base Bar _____	29
4.12.18	Fit Padding _____	29
4.12.19	Fold Control Frame _____	30
4.12.20	Position Battens _____	30
4.13	Transportation and Storage _____	30
4.14	Noise Characteristics _____	30

4 NORMAL PROCEDURES

4.1 General

This section of the AOI describes procedures for normal operations of this aircraft.

WARNING

NO ATTEMPT SHOULD BE MADE TO FLY THE AIRCRAFT WITHOUT APPROPRIATE WEIGHT SHIFT AIRCRAFT FLIGHT TRAINING WITH AN APPROVED INSTRUCTOR.

4.1.1 XT 582 / Cruze Speeds for Normal Operation

Trim Speed	47-52 knots
Stall Speed at Maximum Take Off Weight	34 knots
Take Off Safety Speed & Nominated Approach Speed at MTOW	45 knots
Maximum Speed in Turbulence (V_a)	66 knots
Maximum Level Speed (V_h)	70 knots
Max wind operating conditions (at ground level)	20 knots
Cross winds of up to	12 knots

Table 1 Section 4. Cruze Speeds for Normal Operation

4.1.2 Normal procedures Check List

This section is provided to supply the pilot with more comprehensive information of the normal procedures required to operate this aircraft and is written assuming the pilot has been trained in the assembly and use of a weight shift controlled microlight.

The ultimate responsibility for determining whether the aircraft is in a safe condition to be flown is with **YOU** the pilot in command. Pre-flight inspections are outlined in the following sections and are your responsibility if you are the pilot in command. Unlike the highway, there is no place to pull over and remedy an unsafe problem once you are airborne.

4.2 Wing Assembly Procedure

The following instructions apply to both the Streak 3 and Cruze wings. The sequence of procedures assumes that the wing is packed up. If the wing and base were already assembled this section is not required.

4.2.1 Wing Assembly Procedure

Your instructor should demonstrate the correct assembly and disassembly procedures for your microlight. This section is intended as a reference only and assumes prior knowledge of assembly. AirBorne trike wings should be assembled standing on the control frame. Assembling the wing on the control frame keeps the sail off the ground and therefore less prone to being soiled or damaged. The suggested assembly procedure is as follows:

UNZIP THE BAG. Lay the wing down with the zip up and the nose facing approximately 120 degrees from the wind direction. Unzip the bag but do not completely remove it from the wing. Undo centre 2 clips.

4.2.2 Assemble Control Frame

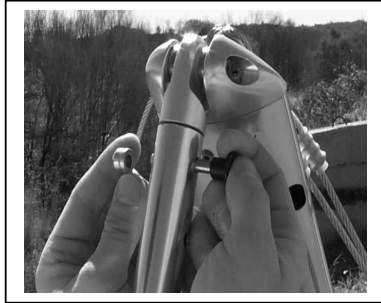

Remove control bar and down tube padding. Spread the control bar down tubes out and insert the base bar onto the alloy knuckle. The pip pin is then inserted from front to back. Ensure that the pip pin end cap is secure. It should not be possible to remove the cap without depressing the pip pin button. Check that all the rigging wires are outside the control frame.

Figure 1 Section 4. Assemble Control Frame

Optional:

If training bars are to be fitted to the control frame follow this procedure.

The left hand side training bar attachment is shown in figure 2, illustrating the correct attachment of the bar on the inside of the control frame. The detail view shows the sequence of components.

1. Bolt, head to the inside of the control frame.
2. Tube
3. Nylon Washer
4. Down Tube Clamp (Both Sides)
5. Wing Nut, turned until both side of the down tube clamp contact. Ensure the training bars are held securely.
6. Safety Pin

Note:

The attachment to the base bar, a PIP pin or bolt secures the training bar to the base bar, and also secures the control frame knuckle. A longer Pip Pin is necessary for the larger diameter tube of the training bar.

The welded base bar attachment has been made to be slightly loose, for ease of fitment.

The right hand side training bar is secured in the same way and is also on the inside of the control frame.



Figure 2 Section 4. LHS Training Bar Attachment

4.2.3 Stand The Wing Up

Rotate the control frame to the vertical position so that the wing is resting on the control bar. Do not attempt to connect the nose catch now. Remove the glider bag and unclip all the wing straps



Figure 3 Section 4. Stand the Wing Up

4.2.4 Spread Leading Edges

Carefully spread both leading edges out half way then spread them both out to the approximate flying position. It is essential that the keel and the leading edges are kept in the same plane or damage will result. Each wing should be kept low to the ground whilst moving forward.

4.2.5 Insert King Post



Remove king post base padding and plug the kingpost into the socket on the rear most hole of the keel. Make sure that the cross bar wires are not twisted and are on either side of the king post.

Figure 4 Section 4. Insert King Post

4.2.6 Insert Main Sail Battens

Remove the battens from the bag. Lay out the top surface battens (curved) in order of descending length toward the tip. Place the “red” battens in the left wing (curve forwards), and the “green” battens in the right. Insert the top surface battens except for the last three battens. Start with the battens closest to the keel. The battens are inserted into the pocket with gentle pressure until they meet resistance. When securing the battens lift trailing edge, push fitting in to sail pocket and rotate fitting downward to lock hinge.

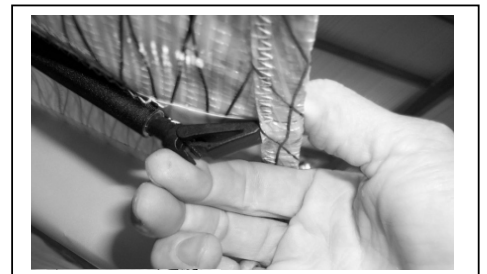

Figure 5 Section 4. Insert Main Sail Battens

4.2.7 Tension Cross Bars



Figure 6 Section 4. Tensioning Cross Bar and Shackle Located in Block.

Pull the webbing handle to tension the crossbars. The handle pull back system gives a mechanical advantage of 2:1. Tension until the cross bar wire shackle is located in the quick clip block, behind the safety button.

4.2.8 Install Pull Back Cover

Ensure that the front Velcro tabs are folded back and secured to the top of the cover.



Figure 7 Section 4. Install Pull Back Cover

Attach Nose Catch



The nose catch should now be attached so that the pip pin is inserted through both the nose catch and channel. Ensure the pip pin cap is secure.

Figure 8 Section 4. Attach Nose Catch

4.2.9 Locate Nose Battens

Insert both nose battens tail end first. Locate the front of the batten on the alloy stubs on the front of the keel tube.

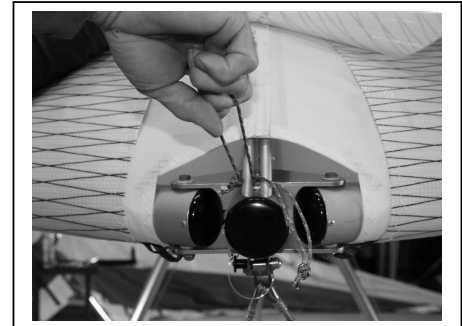
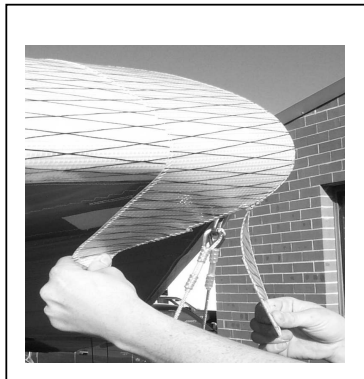

Figure 9 Section 4. Locate Nose Battens

4.2.10 Install Nose Fairing



Attach the nose fairing by applying the top Velcro first then gently tension over the nose plates and attach the Velcro to the undersurface.

Figure 10 Section 4. Install Nose Fairing

4.2.11 Insert Remaining Main Sail Battens

Insert remaining main sail battens at the tips.

4.2.12 Insert Undersurface Battens

The undersurface battens should be inserted as far as possible, without forcing them. The batten should then be pushed with your thumb so that the end is inside the pocket. Use the string to pull the batten back to the rear of the pocket.



Figure 11 Section 4. Insert Remaining Sail Battens

4.2.13 Load Tip Strut

Reach in through the tip and feed the end of the strut out through the undersurface and locate on red webbing. Pull on the bracket in the center of the strut until the strut over centers. Position hand so that it will not get caught in lever mechanism. Note that the photo shows the undersurface undone for improved clarity of operation.



Figure 12 Section 4. Load Tip Strut

You are ready for the wing pre-flight inspection. It is imperative that you carry out this inspection **every time you rig and before you fly.**

CAUTION

ONCE THE WING HAS BEEN PRE-FLIGHTED. CHECK THAT ALL INSPECTION ZIPS ARE FULLY CLOSED.

4.3 Wing Pre-flight inspection

The design of the wing is such that junctions not open to view may be reached from zipped inspection panels. Start at the nose and move around the wing making the following condition inspections, check for damage, wear and security.

Wing pre-flight inspection	
Nose catch, nose bolts, sail tangs (on nose bolts), nose battens	√
Nose cone aligned	√
Leading-edge tubing	√
Cross-bar hinge junction & cross bar tubing	√
Centre undersurface zip	√
Sail tip secure and webbing	√
Tip struts	√
Battens secure and pockets free from damage	√
Reflex bridle lines	√
Cross bar tensioner routing and catch	√
Velcro pull back cover	√
Hang-point / universal bracket & bolts	√
Control frame tubes, hinges, knuckles, connections	√
Trimmer operation, routing pulleys, twists	√
Control frame cables fittings & terminations both ends	√
Junction cross bar & leading edge	√
Top rigging, kingpost located	√
All inspection zips	√
Sail condition inspection, tears, abrasion, stitching & attachment	√
Sail free from water accumulation	√
General inspection of complete wing	√
Full / free movement of the wing when attached to the trike base – to be completed before flight, see section 4.8.1	√
Inspect all cables – inspect for kinks fraying, corrosion – particularly around the NICO press fittings	√

Table 2 Section 4. Wing Pre Flight Inspection

If the wing has been left fully set up for any period, then the following additional checks should be performed:

Extended set up Wing pre-flight inspection	
The symmetry of the wing (batten profile check).	√
All tubes straight, undamaged and without cracks.	√
All cables undamaged, no fraying with secure thimbles/swages.	√
All nuts and bolts secure and locked appropriately.	√
All quick-release fittings secure.	√
Universal bracket undamaged, heart-bolt and back-up strap secure.	√
Sail tension settings correctly aligned and symmetrical.	√
Battens undistorted, and in good condition.	√
All sail seams intact, with no frayed stitching.	√
No tears or nicks in the sail.	√
Trimmer functional and wires not damaged.	√

Table 3 Section 4. Extended Wing Pre-flight

4.4 Attaching Wing to Base

WARNING

THE TRIKE MAST IS FITTED WITH A GAS STRUT TO ASSIST LIFTING THE WING. NEVER ALLOW THE MAST TO BE UNLOADED TOO QUICKLY. HANDS OR OTHER FOREIGN OBJECTS WILL BE SEVERELY DAMAGED IF CAUGHT BETWEEN THE MAST AND SEAT / ENGINE BLOCK.

4.4.1 Attach Mast Retaining Strap



The mast has a gas assist strut to assist lifting the wing when the mast is raised. To hold the mast in position for wing attachment the mast retaining strap should be routed around the rear steering bracket and over the mast. The strap can be adjusted to pull the mast down to the correct height.

Figure 13 Section 4. Attach Mast Retaining Strap

4.4.2 Position The Trike And Wing

Position the wing on its control frame, facing into the wind, with the nose on the ground. The mast tube of the trike should be held down using the strap as described above. Check the ignition switches are off. Wheel the trike behind the wing, rolling the front wheel over the control bar. Apply the trike park brake.



Figure 14 Section 4. Position the Trike and Wing

4.4.3 Attach Mast To Wing U-Bracket



Allow the main tube to rise by loosening the strap until high enough to connect the universal junction to the wing. Insert the bolt with bolt head retaining unit. Tighten wing nut firmly and secure safety pin. The wing should only be attached using the central hole on the U-bracket as shown. Remove mast-retaining strap.

Figure 15 Section 4. Attach Wing to Wing U-Bracket

4.4.4 Position Heart Bolt Retainer in U-Bracket

The standard position for the heart bolt in the U-bracket is in the centre hole, which is the only available point for attachment. The heart bolt retainer is positioned in rear open hole to prevent rotation of the bolt.



Figure 16 Section 4. Heart Bolt Retainer Position

4.4.5 Attach Back Up Loop

Connect back up loop so that it passes over the keel and back to the mast. Ensure safety pin is installed.

4.4.6 Remove Keel Extension

Disengage the brake of the trike, lift the nose of the wing to allow the front wheel to be rolled rearward over the control frame so that the base bar is forward of the cockpit. Re-engage the brake.

Remove the keel extension by removing safety ring and pulling out the clevis pin. Remove keel extension. Store with pack up gear.

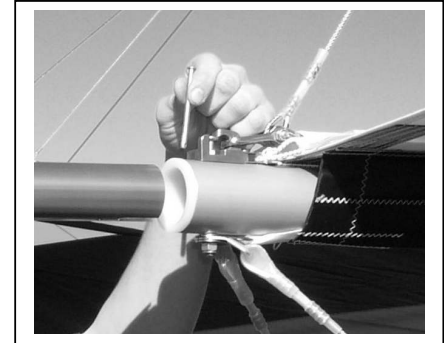

Figure 17 Section 4. Remove Keel Extension

4.4.7 Rotate Wing



Go to the nose of the wing and with the mast brace tube in one hand and the control bar in the other lift the base bar. Rotate the wing until the rear of the keel rests on the mast. In strong winds maintain a firm grip on the wing.

Figure 18 Section 4. Rotating Wing

4.4.8 Insert Mast Lever

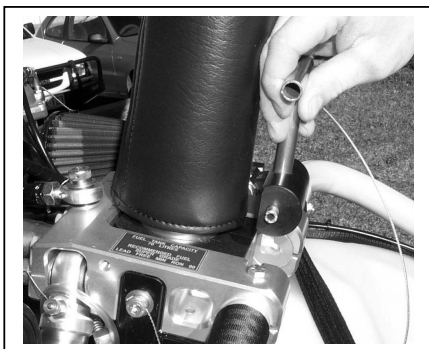

Insert the lever so that the flat section is facing toward the mast.

4.4.9 Attach Mast Brace

Bring mast brace into position and allow the outer sleeve to slide into position. Install the top pip pin and cap. Install lower pip pin and cap.

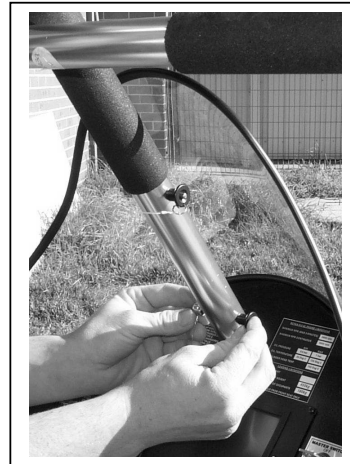

Figure 19 Section 4. Insert Mast Lever

4.4.10 Load Mast Lever

Once the lever is located correctly rotate the lever down 180 degrees until it is securely loaded. Fold the seat back up into position.

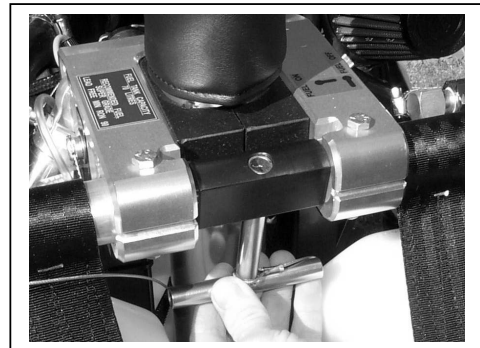

Figure 20 Section 4. Load Mast Lever

4.4.11 Park The Aircraft



The aircraft should be parked in a crosswind position with the wings base tube secured to the mast brace with the bungee supplied.

NOTE

The wingtip facing the wind should be lowered.

Figure 21 Section 4. Park the Aircraft

4.5 Complete Trike Pre-Flight Inspection

Ensure that the ignition switches are off prior to inspection. Daily inspections as outlined in the Rotax Operator's Manual should be carried out in conjunction with the following inspections.

Trike base Pre-flight Inspection	
No leaks from fuel system and engine, fuel lines secure.	√
No leaks from oil system and engine.	√
Fuel On/Off valve in the ON position.	√
Fuel filter clean and operational.	√
Fuel drain valve - check for any water in tank sump by draining a small quantity into a container.	√
Sufficient fuel for flight.	√
Oil level for oil injection OK. (See Photo Below Fig 22)	√
Coolant level. Between max and min level on coolant bottle.	√
Rotary valve oil level OK.	√
Radiator hoses secure and operational.	√
Propeller: free of splitting, denting, delamination, nicks. Blade tape condition.	√
Propeller hub assembly secure and tie wired.	√
No cracking in tyre treads, or evidence of cracking around the rim.	√
Rear end and wheel spats secure.	√
No bolts bent, fractured or evidence of corrosion.	√
Electrical & instrumentation system secure and operational.	√
Throttle operation, both foot and hand throttle. Verify free and full movement..	√
Seat belt attachments secure.	√
Steering damper - adjust to desired setting.	√
All engine components secure - air filter, muffler, plug leads, locking wires.	√
Mast brace PIP pins secure.	√
Mast over centre latch loaded and secure.	√
Vents: oil tank, fuel tank, Pitot entry.	√
Mechanical components. Rotate propeller clockwise and observe for noise or excessive resistance.	√
General inspection of complete trike.	√
Wing & base universal bracket secure. Back up webbing strap secure.	√

Table 4 Section 4. Complete Trike Pre-Flight Inspection

4.6 Fuelling

Fuel flow is from a single fuel tank fitted with a self-venting tube. The fuel system is fitted with a shut off valve located on the rear left hand side of the seat frame. Be sure this valve is in the **ON** position before starting engine.

Never refuel if fuel could be spilled on hot engine components. Use only safety approved fuel containers and never transport fuel in an unsafe manner.

The fuel tank has a water drain mounted at the base and to the rear of the tank. The fuel system has an in-line fuel filter, which is mounted at the front of the tank. This filter can be easily disassembled for cleaning and inspection (see base maintenance manual).

WARNING
ENSURE THE AIRCRAFT IS EARTHED TO AVOID STATIC DISCHARGE IGNITING FUEL DURING THE REFUELLING OPERATION.

The Edge XT series fuel levels are marked on the right side of the fuel tank. The fuel levels are marked at 10 litres, 20 litres, 30 litres, 40 litres, 50 litres and 60 litres.

4.6.1 Fuel Tank Capacity

The properties of the fuel tank material cause an increase in capacity after the first 2 to 3 tanks of fuel. Initial capacity is 64 litres with the "aged" capacity 70 litres. The fuel level markings have been positioned for the fuel tank capacity at 70 litres.

4.6.2 Fuel Quantity

A sight gauge is provided on the starboard side of the aircraft, visible through the soft side. Its purpose is to provide fuel volume measurement for calculation of aircraft weight during fuelling of the aircraft and to provide the pilot with a visual indication of the quantity of the remaining fuel. The calibration is valid for the aircraft sitting on level ground and indicates total fuel, not usable fuel.

The trike base assumes various flight attitudes according to weight, flight, speed and power effecting the indicated value of fuel quantity in flight. The useable fuel quantity is selected for the worst case condition of aircraft attitude.

Zero useable fuel is indicated by the fuel level reaching the bottom of the sight gauge during level flight.

When the level indicates zero useable fuel, the tank contains 3 litres of unusable fuel.

4.7 Engine Lubricating Oil

Engine lubrication is supplied via the oil injection system which is gravity fed. The oil consumption is defined by engine rpm and the lever position. The lever is actuated via a Bowden cable connected to the throttle cable. The oil injection system has a capacity of 2 litres.

The nominal oil usage is 50:1 (2%) which would require 1.4 litres for a full tank of fuel.

The photo opposite gives an indication of oil levels required for the nominated fuel level. The oil tank has a low oil level switch (Alarm Level), which actuates the alarm on the Skydat instrument. However if the oil tank is filled when the fuel tank is filled the low level alarm should never come on. The remaining quantity of oil at "Alarm Level" is 500mL when the alarm is actuated which leaves enough oil to find a suitable landing area.

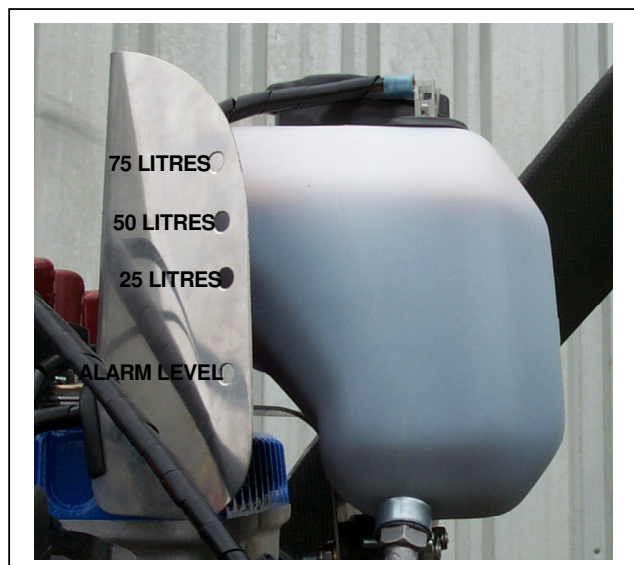

Figure 22 Oil Level

WARNING

THE OIL INJECTION TANK HOLDS ENOUGH OIL TO LUBRICATE 100 LITRES OF FUEL. THE OIL INJECTION TANK SHOULD BE FILLED EVERY TIME THE FUEL TANK IS FILLED.

Oil Specifications

Oil used is Super two stroke ASTM/CEC standards, API-TC classification (consult your Rotax dealer for the recommended oil to suit your operating conditions).

4.8 Helmet Recommendation

The open cockpit of the Edge XT exposes the occupants to the elements during flight and exposes them to objects outside of the aircraft in an emergency situation.

Helmets and eye protection are recommended for occupants for protection from precipitation, strike by insects and birds. Helmets are also recommended for risk reduction during an emergency landing of the aircraft. The helmets recommended for use in the aircraft are those certified to the EN 966 standard, that is applicable to helmets for air sports. The standard prescribes tests for penetration resistance, shock absorbing properties, field of vision and head mobility.

4.9 Normal Procedures Check List

The following checklists should be used as a reference. More detailed procedures are found in the Amplified Procedures section, which follows.

Prior to flight a thorough pre-flight inspection of the aircraft should be carried out. Details of the pre-flight inspection are shown earlier in this section.

4.9.1 Before Starting Engine

Pre-Flight Inspection	Completed
Full / free movement of the wing when attached to the trike base	Completed
Passenger Briefing	Completed
Safety Belts	Secure
Helmets	Secure
Intercom Connection	Secure
Brakes	On / Park
Intercom Connection	Secure
Parachute (If fitted)	Remove Safety Pin

Table 5 Section 4. Before Starting Engine Check

4.9.2 Starting Engine

Park Brake	On
Fuel Cock	Open
Hand and Foot Throttle	Off - (Idle Position)
Key	On
Instrument	On
Ignition	On
Choke	On
Propeller	Clear
Depress Start Button	Push - When engine fires Release
Choke	Off
Engine Running	Adjust Idle to 2000 rpm (2 mins)

Table 6 Section 4. Starting Engine Check

4.9.3 Before Take Off

Park Brake	On
Choke	Off
Warm Up	Adjust Idle to 2500 rpm (temp to reach 65 deg C)
Ignition Check	3000 rpm Speed drop with only one ignition must not exceed 300 rpm
Trimmer	Set Fast (Increase trim speed)
Fuel Quantity	Check Sufficient for task
Instruments	Check
Circuit Breaker	Check
Harnesses	Secure
Helmets	Secure
Throttle Response	Full On (3 seconds)
Controls	Pitch and Roll Full and free movement – completed before engine start as well as just prior to take off.

Table 7 Section 4. Before Take Off Check

4.9.4 Take Off and Initial Climb

Pitch Control	Neutral	
Hand Throttle	Off	
Foot Throttle	Full On (Reduce for minimum TOW)	
Directional Control	Nose Wheel Steering Straight	
Airspeed	CRUZE	45 KIAS

Table 8 Section 4. Take Off and Initial Climb Check

4.9.5 Climb

Foot Throttle	Full On (Reduce for minimum TOW)	
RPM	5000 RPM (Reduce to 5000 rpm once climb established. No change if using a reduced power take off)	
Airspeed	CRUZE	45-50 KIAS

Table 9 Section 4. Climb Check

4.9.6 Cruise Speeds

Hand Throttle	Adjust for Level Flight	
Airspeed	CRUZE	50-55 KIAS

Table 10 Section 4. Cruise Check**4.9.7 Descent**

Foot Throttle	Reduce	
Hand Throttle	Off	
Airspeed	CRUZE	45-50 KIAS

Table 11 Section 4. Decent Check**4.9.8 Landing**

Hand Throttle	Off	
Airspeed	CRUZE	45 KIAS
Directional Control	Nose Wheel Steering Straight	
Braking	Off Then as required	

Table 12 Section 4. Landing Check**4.9.9 After Landing**

Parking Brake	On As required	
Ignition Switch	Off	
Electrical Switch	Off	
Radio Equipment	Off	
Controls	Secure	
Parachute (If fitted)	Insert Safety Pin	

Table 13 Section 4. After Landing Check

4.10 Amplified Procedures

4.10.1 Before Starting

Safety is everyone's business. Included are only some important safety tips. Keep a good lookout, be thoughtful and always show your intentions prior to starting.

Prior to flight a thorough pre-flight inspection of the aircraft should be carried out. Details of the pre-flight inspection are shown earlier in this section. Make sure all engine controls are operative and you understand the on/off positions of the throttle and ignition. These controls are readily accessible and you must be able to operate them instinctively without hesitation.

The primary throttle control is foot-operated and complemented by the hand throttle (forward for full power and rearward for power off). The ignition switches are on the right hand side of the seat frame (forward for on and rearward for off).

Never run the engine on the ground with the propeller turning unless you are doing so in a run up area and can observe anyone or anything entering the danger area. It is recommended that the engine not be run for any long periods whilst stationary on the ground. Possible damage to the engine may occur due to overheating of the engine fluid.

Before starting your engine you should read and be familiar with the engine manual.

Run through the following checklist (pronounced "twimpfish") prior to starting the engine for each and every flight.

- T** Throttle - full and free movement
- Tyres - inflated and serviceable
- W** Wind - check direction and strength
- Wires - secure and airworthy
- M** Mixture - chokes off
- P** Pins - fitted and secured
- F** Fuel - On and sufficient
- I** Instruments - check, set and operational
- S** Switches - ignition check (all switches on)
- C** Controls - pitch and roll - full and free movement
- Chocks - removed (secured in aircraft)
- H** Harness and **H**elmet in place and secure

Remember that the pilot in command has the ultimate responsibility for the airworthiness of the aircraft in which they fly.

4.10.2 Starting the engine

All controls should be checked with the ignition OFF. Passengers should have seat belts secure and be briefed for the flight.

The engine should be started with the pilot in the front seat. The following procedure should be used:

- Park brake is locked in the on position

WARNING
LOCK THE WHEEL BRAKE TO REDUCE ANY POSSIBILITY OF DANGER TO ANY PERSON/S DURING ENGINE STARTING.

CAUTION
REMEMBER CLEAR PROP!

- Fuel cock open
- Hand and foot throttle off
- Turn key switch and power up instrument
- Switch both ignitions **ON**
- Apply full choke unless the engine is hot
- Check visually that the propeller area is clear and call “**Clear Prop**” out loud
- Depress start button. If the engine refuses to start switch off the ignition before investigation
- When the engine starts, increase the engine RPM to a little above idle and release the chokes
- Warm up the engine. Minimum Temperature should be reached before take off. Operate for 2 min at 2000 rpm continue at 2500 rpm until minimum temperature of 65 deg C is reached

WARNING

NEVER LEAVE YOUR AIRCRAFT UNATTENDED WHILE THE ENGINE IS RUNNING.

Keep an aircraft log and enter any unusual engine behaviour. Do not fly unless you have corrected a given problem and recorded the correction in the log.

4.10.3 Taxiing

Taxiing in normal conditions is fairly straight forward.

With the engine idling the brake lever should be depressed which will disengage the park brake. The control frame should be positioned so that it is in the approximate position for normal trim speed. The pilot's feet actuate steering on the ground. Left turn occurs when the right footrest is pushed forward. Right turn occurs when the left footrest is pushed forward.

NOTE

Control sense for turning is opposite to that of a conventional three axis aircraft.

When taxiing in strong wind conditions the following procedures apply:

- **Head Wind** conditions requires the nose of the wing to be lowered just below the trim position
- **Down Wind** conditions requires the nose of the wing to be raised just above the trim position
- **Cross wind** conditions requires the upwind tip to be lowered

4.10.4 Before take off

Before flight a full-throttle check is to be carried out. During this operation the pilot must be seated in the cockpit and prepared to switch off the ignition at very short notice if an emergency should arise.

CAUTION

BEWARE OF LOOSE STONES IN THE RUN UP AREA. LOOSE STONES CAN BE SUCKED UP BY THE PROPELLER AND CAUSE SEVERE PROPELLER DAMAGE IN A VERY SHORT TIME. RUN UPS ARE BEST CONDUCTED ON A CLEAR SEALED SURFACE OR ON GRASS, NEVER ON GRAVEL

The two ignition circuits should be tested with the engine running at 3000 rpm. Ignition one should be switched off and the RPM drop should not exceed 300 rpm. Both ignitions should be in the on position and ignition two should be turned off and the RPM drop should not exceed 300 rpm. Ensure both switches are in the on position after ignition circuit testing.

During take off and landing the recommended trimmer setting is in the fast trim position. It is acceptable to set the trim as far as mid trim position for take off and landing. The trimmer decal on the control frame upright, adjacent to the trimmer knob indicates the trim position.

4.10.5 Take Off

AirBorne trike wings have a neutral static balance allowing a safe take-off that is controllable under all suitable flying conditions.

Take off should be made on full power with only the foot activated throttle used during take off.

The take off run is the measured ground distance covered until the aircraft reaches a height of 50 feet above the average elevation of the runway used. Refer to Section 5 for details of takeoff performance.

During the takeoff run, the wing should be held in the trim position with the wings level. Accelerate smoothly to the take off safety speed. If the aircraft is fully loaded you will require full power.

When the aircraft reaches the take off safety speed the control bar should be pushed steadily forward until the trike lifts and rotates quickly on the main wheels. As the aircraft leaves the ground the control bar must be eased back to maintain take off safety speed.

Maintain your engine in top condition and assume it's going to stop running at any time. Leave yourself a way out for an unexpected engine failure.

Never fly your aircraft at locations, airspeeds, altitudes, or under any circumstances from which a successful engine off landing cannot be attempted.

4.10.6 Climb

Initial climb out should be made on full power for maximum take off weight. Approximately 2/3 of maximum take off power is considered comfortable for a minimum weight takeoff. Take off distance will be extended at reduced power.

Once climb is established power should be reduced to below maximum continuous power of 6800 rpm. A minimum of take off safety speed should be used. At this speed the aircraft would round out nicely into a glide should the engine fail.

Avoid pitching the nose of the wing up more than 45 degrees to the horizon. Very steep climbs are dangerous and can result in a stall followed by a severe pitching of the nose forward. Professional training is required for the correct procedures of unusual attitude recovery.

CAUTION

HIGH-ANGLE CLIMB-OUTS NEAR THE GROUND SHOULD BE AVOIDED.

WARNING

AT LOW ALL UP WEIGHTS, THE TAKE OFF CLIMB OUT AT THE TAKE OFF SAFETY SPEED CAN RESULT IN HORIZONTAL PITCH INCLINATIONS IN EXCESS OF THE PLACARDED 45 DEGREES MAXIMUM. THE PILOT MUST BE AWARE OF THIS AND SHOULD KEEP WITHIN THE PLACARDED LIMITATIONS BY LOWERING THE ATTITUDE OR REDUCING ENGINE POWER.

WARNING

REDUCED POWER TAKE OFFS WILL EXTEND TAKE OFF DISTANCE. IT IS THE PILOT'S RESPONSIBILITY TO ENSURE THAT THERE IS SUFFICIENT RUNWAY AVAILABLE TO CLEAR ALL OBSTACLES WHEN CONDUCTING REDUCED POWER TAKE OFFS.

4.10.7 Cruise

When the desired flight altitude is reached the aircraft may be levelled out and throttle reduced to that required to maintain level flight.

The hand-operated throttle on the right side of the seat frame can be used to set engine rpm. Once the hand throttle is adjusted the pressure on the foot pedal may be removed. When the hand throttle is actuated increase power can still be achieved with the use of the foot throttle. The rpm will always return to the cruise setting when foot pressure is removed. If the hand throttle is set a reduction in RPM is not achievable using the foot throttle. The hand throttle must be in the off position to achieve low RPM.

4.10.8 Stalls

In practice it is only possible to induce a nose down stall of the aircraft in level flight at high take off weights. The onset of stall is indicated by a significant increase in control bar loads.

Recovery from a mild stall is very gentle, whether power is on or off. Recovery is quick, with height loss of less than 50 ft with no tendency to break away suddenly. A stall would have to be forced violently, to induce a danger.

When practising stalls make sure you have sufficient altitude. Push the control bar out so that the airspeed is reduced at a maximum of 1 knot per second, and the aircraft will reach a minimum steady flight speed without dropping a wing. The sink rate will increase in this minimum speed mode more than two fold.

If the airspeed is decreased by rapidly raising the nose the wing will stall. Rapid decrease of airspeed in the order of 2-3 knots per second will see an altitude loss of up to 100ft. See section 3.3.12 for recovery procedures.

Never stall with the nose pitched up too high. This is a dangerous manoeuvre and can result in a tail slide followed by a severe tumble. As a guideline, the nose up angle at which the aircraft stalls is about the nose down angle it will recover at.

4.10.9 Descent, Approach and Landing

Landing should always be into wind with a long straight approach.

The landing distance specified in section 5 is the measured ground distance covered from an approach at 50 feet above the average elevation of the runway used until the aircraft makes a complete stop.

An approach to the airstrip may be made with or without power, but in either case the airspeed should be maintained above the nominated approach speed.

During take off and landing the recommended trimmer setting is in the fast trim position. It is acceptable to set the trim as far as mid trim position for take off and landing. The decal on the control frame upright, adjacent to the trimmer knob indicates the trim position.

The aircraft should be flown on final approach at or above the nominated safety speed. The additional airspeed allows for wind gradient, and to provide greater controllability in the rough air that may lie close to the ground. Maintaining airspeed on final is very important for engine-off landings, allowing a margin for round out before touchdown.

The trike is designed to land with the rear wheels touching down slightly before the nose wheel. Once firmly on the ground aerodynamic braking may be achieved by pulling in the control bar, then applying the front nose wheel brake.

NOTE

In the case of a heavy landing the maintenance manuals for both the wing and the base should be referenced. It must be noted that after a hard landing, your aircraft must be completely checked.

4.10.10 Cross Wind Landing and Take Off

Pilots with less experience should avoid landing or taking off in conditions with high crosswind components, as skills do not always match the capabilities of the aircraft. Crosswind landings or take off with low wind components up to 8 knots are quite safe and controllable, even to the inexperienced pilot.

The nominated approach speed should be increased by 5 knots when landing in cross wind conditions of 10 knots or more.

WARNING

NEVER STALL THE AIRCRAFT WITH THE NOSE PITCHED UP BEYOND 45 DEGREES. MANOEUVRES BEYOND THIS ARE DANGEROUS AND CAN RESULT IN A TAIL SLIDE FOLLOWED BY A SEVERE TUMBLE.

REFER TO SECTION 3.3.12 OF THIS FLIGHT MANUAL FOR DETAILS OF THE PROCEDURES FOR RECOVERY FROM UNUSUAL ATTITUDES.

After touchdown in cross wind conditions the relative airflow over the wing will become increasingly span wise (from tip to tip) as the aircraft slows down. The upwind wing tip should be lowered slightly (the amount depends on the wind strength), and the undercarriage wheels will retain firm contact with the ground.

Take off procedure is unchanged for the nominated crosswind limit. The upward wing may need to be lowered at the start of the take off procedure in higher cross winds.

4.10.11 Baulked Landing

During a situation where a baulked landing (go around) is required, normal take off power and procedures should be used.

4.10.12 Stopping the Engine

To stop the engine after a period of running, the ignitions should be switched off at idle. Switching off at high RPM floods the engine and makes restarting difficult. If the engine has been running under full power allow the engine to cool at idle, before switching off.

4.11 After Landing / Securing

After landing and when in the parking area apply parking brake and lock. Switch the ignition, electrical switch and radio equipment off. The aircraft should be parked in a crosswind position with the base tube secured to the mast brace with the bungee supplied. The emergency parachute safety pin should be inserted before leaving the aircraft.

4.11.1 De-Rigging Procedure

Careful attention to the recommended rigging and de-rigging sequences will protect the aircraft from the risk of unnecessary damage.

The de-rigging procedure is a direct reversal of the rigging procedure. A summary of the procedure follows:

4.11.1.1 Remove Wing from Base

See section 4 (Attaching Wing to Base) and use reverse procedure

- Apply park brake.
- Remove pip pins from the front support compression tube. Slide outer mast brace up and insert pip pin through lower hole (this will secure the inner and outer tubes for the lowering phase).
- Unload and remove over centre latch.
- Lower the wing until the control bar is on the ground.
- Secure mast with strap to base tube.
- Unbolt the trike from the U-bracket; remove safety loop and wheel out the trike unit.
- Reinstall keel extension tube.

4.12 Wing Break Down Procedure

This section assumes that the wing has been removed from the base. The wing should have the keel extension fitted with the clevis pin and ring installed. This section is intended as a reference only and assumes prior knowledge of the break down procedure. Further reference for cover positioning can be found in the wing Illustrated Parts Catalogue (IPC).

4.12.1 Detension Tip Struts

Fold the tip struts pushing the hinge joint towards the center of the wing. Once the sail end of the strut is inside the undersurface fold the strut forward and towards the tip of the wing and locate on top of leading edge.

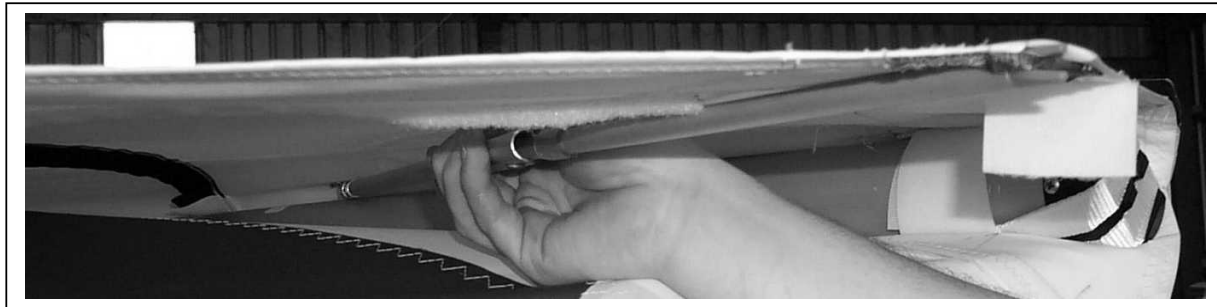
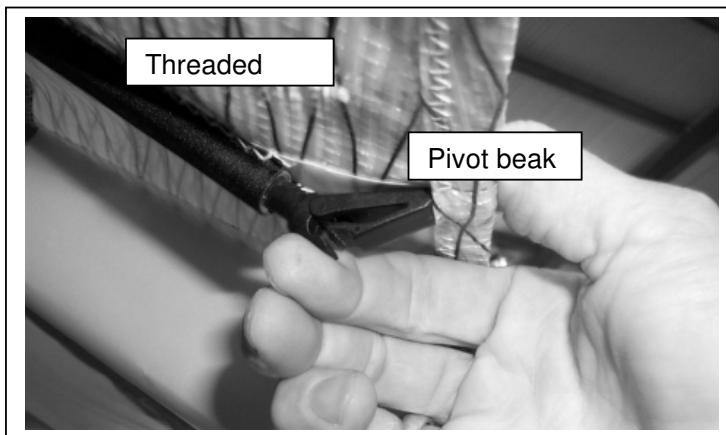

Figure 23 Section 4. Detension Tip Strut

4.12.2 Remove Tip Battens



Remove outermost three tip battens. Unclip 'pivot beak' from 'threaded end'. Rotate *pivot beak* and remove from sail as shown. To adjust batten load tension, release *pivot beak* from sail and rotate batten clip. See maintenance manual for adjustment details.

Figure 24 Section 4. Remove Tip Battens

4.12.3 Remove Undersurface Battens

Insert finger through string loop and pull batten forward. Once the batten is forward pull string down to remove from oval pocket. Slide batten rearward until all the way out.



Figure 25 Section 4. Remove Undersurface Battens

4.12.4 Fit Tip Bags



Roll sail at the tips inwards and parallel to the leading edge. Slide the tip bag over the end of the leading edge. The barrel lock unit can be used to tension the bag bungee.

Figure 26 Section 4. Fit Tip Bags

4.12.5 Fit U-Bracket Cover

Unzip undersurface approximately 1 meter to allow better access to fit the U-bracket cover. Pass the cover up over the keel with the webbing strap facing to the rear of the wing. Velcro around each down tube (photo shown is a rear view).



Figure 27 Section 4. Fit U-Bracket Cover

4.12.6 Velcro U-Bracket Face Cover



Position the face cover so that it is facing forward. The cover is designed to protect the wing bag when packed (photo shown is a front view).

Figure 28 Section 4. Velcro U-Bracket Face Cover

4.12.7 Trimmer Cover

Position the trimmer handle so that the handle is at 90 degrees to the down tube with the knob facing forward. Fit the trimmer cover.

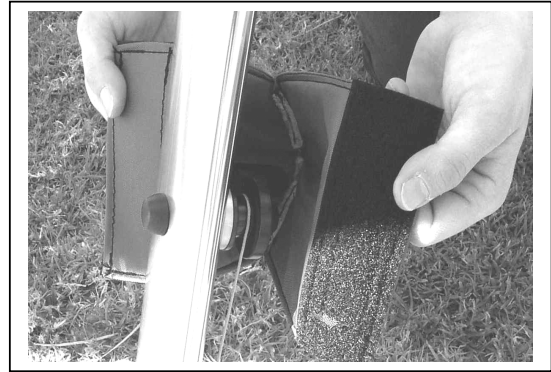

Figure 29 Section 4. Trimmer Cover

4.12.8 Disconnect Nose Catch and Remove Nose Cone



Remove the nose cone. Disconnect nose catch by removing the pip pin. The pip pin button should be depressed with the thumb while simultaneously pulling the pip pin out. Re-insert pip pin in nose channel.

Figure 30 Section 4. Disconnect Nose Catch and Remove Nose Cone

4.12.9 Remove Sail Cowling

Undo the securing Velcro tabs at the front of the cowl. Remove the sail cowling from the top of sail.



Figure 31 Section 4. Remove Sail Cowling

4.12.10 De-Tension Pull Back Cable



Depress quick clip with left thumb. Use right hand to pull on the webbing handle. Remove the shackle from the quick clip block and allow webbing handle to move forward.

Figure 32 Section 4. De-tension Pull Back Cable

4.12.11 Remove Main Sail Battens

Pull the leading edges together approximately 1/2 metre. Remove the remaining main sail battens. Insert battens in the batten bag.

NOTE

The straight battens are inserted in separate pockets.



Figure 33 Section 4. Remove Main Sail Battens

4.12.12 Remove King Post



Remove the king post by lifting upward. Fit the quick clip king post base cover around the quick clip. Insert the king post in to pouch.

Figure 34 Section 4. Remove King Post

4.12.13 Fold Leading Edges

Fold both wings in symmetrically, bringing both leading edges back at the same time or in small steps side to side.

Roll the sail inwards parallel to the leading edge. Attach a strap around one wing. Repeat for the other side. Fit the keel end pouch.



Figure 35 Section 4. Fold Leading Edges

4.12.14 Attach Straps

Once the leading edges are together apply slight pressure downwards on the keel to raise the leading edges above the down tubes and attach strap around both wings and keel. Attach remaining straps so that they are evenly spaced.

4.12.15 Fit Wing Bag

Position the wing bag to the nose of the wing. Stretch bag down the wing to enclose the tips.

4.12.16 Roll Wing

Hold the wing and down tube and roll the wing onto its back with the control frame to the side.

4.12.17 Disconnect Base Bar



Depress pip pin button and remove pip pin from base bar. Fold down tubes together with base bar folded out. Re-insert the pip pin.

Figure 36 Section 4. Disconnect Base Bar

4.12.18 Fit Padding

Fit the base bar and down tube covers. Velcro the base bar cover in whilst holding the base bar in position.



Figure 37 Section 4. Fit Padding

4.12.19 Fold Control Frame

Undo centre two wing straps. Route flying wires between the down tube and lower the control frame into the wing whilst holding tension on wires. Avoid kinking the flying wires.

4.12.20 Position Battens



Stow the battens with the curve down at the rear of the glider bag. Reattach wing straps so that the control frame and battens are within the leading edge pockets. Zip up the wing bag.

Figure 38 Section 4. Position Battens

4.13 Transportation and Storage

The wing must always be transported inside its bag, and the bag zip should face downwards to prevent the entry of rainwater. During transportation, or when stored on slings, the wing must be supported at its centre and at two points not more than one metre from each end. The padding supplied with the wing must be used to prevent chaffing during transport.

Supports should be softly padded, and any support systems used for transport, such as roof racks, must use attachment straps that are sufficiently secure to eliminate the possibility of damage from vibration and movement.

Avoid damage to your wing by using well-padded racks. As the wing is quite heavy a strong set of racks are required. Flat straps should be used for tie downs to avoid damage to leading edge Mylar.

When transporting the trike base the use of trike and prop covers to protect your aircraft from road grime (and idle fingers) is recommended. Tie the propeller to the trike to stop it from rotating at speed.

Check that the back of the wing is well clear of the front mast with the trike on the trailer. Remember that you have an overhanging load when manoeuvring in tight places.

Store the wing in a dry room off the ground; air the wing out regularly to avoid mildew, and never store wet.

See your Rotax Manual for precautions to be observed if you intend to store the aircraft without use for extended periods.

4.14 Noise Characteristics

Noise levels to be advised.

PERFORMANCE

PERFORMANCE	1
5 PERFORMANCE	2
5.1 General	2
5.2 Take Off and Landing	2
5.2.1 Take Off XT 582 / Cruze	2
5.2.2 Landing XT 582 / Cruze	3
5.3 Climb	4
5.3.1 XT 582 / Cruze	4
5.4 Airspeed Calibration	4
5.5 Stall Speeds	5
5.5.1 XT 582 / Cruze	5
5.6 Glide	5
5.6.1 XT 582 / Cruze	5
5.7 Cruise Performance	6
5.7.1 XT 582 / Cruze	6

5 PERFORMANCE

5.1 General

The performance data in the following section has been computed from actual flight tests with the aircraft and power plant in good condition and using average piloting techniques. It should be noted that piloting techniques, climatic conditions and aircraft condition will cause significant variation to these performance figures.

5.2 Take Off and Landing

5.2.1 Take Off XT 582 / Cruze

Performance at MTOW	Metric	Imperial
Take off Distance to 15 m (50 ft)	280 m	918 ft

Table 1 Section 5. Cruze Take Off

Takeoff distances are specified for:

Sea Level with:

Max Take Off Power

A level dry runway

With short grass

Still wind

And temperature of 15 deg C.

The following factors will increase takeoff distance:

Reduced Power Take Off

Higher drag runway surfaces such as wet or long grass

Tail wind

Uphill takeoff

OAT above 15 deg C

Runway altitude above sea level

The pilot is required to take into account the effect of the above when determining takeoff distance.

5.2.2 Landing XT 582 / Cruze

Performance at MTOW	Metric	Imperial
Landing Distance from 15 m (50 ft)	306 m	1004 ft

Table 2 Section 5. Cruze Landing

Landing distances are specified for:

Sea Level with

A level dry runway

With short grass

Still wind

And temperature of 15 deg C.

The following factors will increase landing distance:

Lower drag runway surfaces such as tarmac

Tail wind

Down hill landing

OAT above 15 deg C

Runway altitude above sea level.

The pilot is required to take into account the effect of the above when determining landing distance.

Crosswind components of up to 12 knots at maximum AUW are within aircraft operating limitations.

Always exercise judgement when selecting locations for take off and landing. Leave adequate margin for appropriate control action in the event of sudden engine failure or turbulence being encountered.

CAUTION
TAKE OFF AND LANDING DISTANCES MUST
BE INCREASED BY 20% FOR EACH 1000
FEET OF ALTITUDE ABOVE SEA LEVEL.

5.3 Climb

5.3.1 XT 582 / Cruze

Performance at MTOW	Metric	Imperial
Climb rate (45 kts)	3.7 m/sec	721 ft/min
Best Climb Speed	45 kts	45 kts
Sea Level Gradient of Climb	16.7%	16.7%

Table 3 Section 5. Cruze Climb

Climb data is for ISA conditions (Sea Level at 15 deg C)

5.4 Airspeed Calibration

All Air Speeds in this AOI are expressed as Knots Indicated Air Speeds (KIAS) unless otherwise noted. Below is a table showing the relationship between Indicated Air Speed and Calibrated Airspeed. The table assumes zero instrument error.

Indicated Air Speed (KIAS)	Calibrated Air Speed (KCAS)
35	35
40	39
45	43
50	47
60	55
70	63
80	70
85	74

Table 4 Section 5. Airspeed Calibration

5.5 Stall Speeds

5.5.1 XT 582 / Cruze

Performance	Metric
Stall Speed @ MTOW	34 kt
Stall Speed @ 320 kg TOW	28 kt

Table 5 Section 5. Cruze Stall Speeds

5.6 Glide

Glide figures have been determined with the engine off at maximum take off weight with the trimmer set in the fast configuration

5.6.1 XT 582 / Cruze

Performance - 45 kts at MTOW	Metric	Imperial
Descent Rate	3.0 m/s	597 ft/m
Descent Gradient	14%	14%
Glide Distance from 1000ft AGL	2.2 km	1.4 miles

Table 6 Section 5. Cruze Glide

Glide data is for ISA conditions (Sea Level at 15 deg C)

5.7 Cruise Performance

5.7.1 XT 582 / Cruze

Performance at MTOW	Australian	European	USA
Cruise Speed	50 kts	92 km/hr	57 mph
Typical Fuel Burn @ Cruise (See Note)	14 lt/hr	14 lt/hr	3.7 gal/hr
Range @ Cruise	433 km	433 km	269 miles

Table 7 Section 5. Cruze Cruise Performance

NOTE

Fuel consumption figures are included as a guide only. The consumption figures should not be used for planning purposes. Changes in aircraft configuration, load, altitude, wind strength and direction as well as climatic conditions will cause significant variation in fuel consumption.

Aircraft Operating Instructions Edge XT 582 /Cruze

WEIGHT BALANCE & EQUIPMENT

WEIGHT BALANCE AND EQUIPMENT

WEIGHT BALANCE AND EQUIPMENT	1
6 WEIGHT BALANCE AND EQUIPMENT	2
6.1 General	2
6.2 Aircraft Weight	2
6.2.1 Aircraft Weighing Information	2
6.2.2 Standard Equipment	3
6.2.3 Optional Equipment	3
6.3 Typical Aircraft Weights	3
6.3.1 Weighing Procedure	4
6.3.2 Weight Calculator	4
6.3.3 Metric Fuel Calculator	4
6.3.4 Imperial Fuel Calculator	5

Aircraft Operating Instructions Edge XT 582 /Cruze

WEIGHT BALLENCE & EQUIPMENT

6 WEIGHT BALANCE AND EQUIPMENT

6.1 General

This aircraft must only be flown solo from the front seat. All aircraft operations may be carried out whilst solo, as when the aircraft is flown dual.

The fuel capacity must always be considered when measuring the AUW of the aircraft. Remember that fuel is measured at 0.7 kg per litre and fuel quantity will alter the aircraft's performance during take off and landing. A fuel volume calculator can be found in section 6.3.2.

6.2 Aircraft Weight

The table in section 6.2.1 shows the weight of the aircraft as weighed during final Quality Assurance at the factory. The following page shows, if applicable, the options that were included when the aircraft was weighed. The empty weight shown below can also be found on the limitations placard on the aircraft dash panel. A second issue section is included which allows the weight to be revised if any additional equipment is installed or if the empty weight of the aircraft changes for any reason. If the empty weight has changed then revised placards are available from Airborne. The weight calculators allow for additional weight to be accounted for.

6.2.1 Aircraft Weighing Information

Typical wing weight Cruze (51 kg)

Aircraft Type: AirBorne WindSports EDGE XT 582 CRUZE				
	Serial No	Issue	Date	Empty * Weight (kg)
Trike Base	XT582-	1		kg
Unusable Fuel	3 Litres	1		2 kg
Wing	-	1		kg
Training Bars	1.4 kg (If applicable)	1		
Issue 1 Aircraft Empty Weight*				kg
Trike Base	XT582-	2		kg
Unusable Fuel	3 Litres	2		2 kg
Wing	-	2		kg
Training Bars	1.4 kg (If applicable)	2		
Issue 2 Aircraft Empty Weight *				kg

Table 1 Section 6. Aircraft Weight

*Empty Weight for the aircraft comprises of:

- Standard equipment as per section 6.2.2
- Optional equipment as per section 6.2.3
- Full coolant, full engine oil and unusable fuel

The keel extension and pack up gear are not included in the empty weight

Aircraft Operating Instructions Edge XT 582 /Cruze WEIGHT BALLENCE & EQUIPMENT

6.2.2 Standard Equipment

STANDARD EQUIPMENT	Fitted
Engine Type	ROTAX 582 UL DCDI / mod 99
Engine Serial Number	
Gear Box Type	E Type 3.47 : 1
Propeller Type	BOLLY BOS 3 - 68 INCH
Airspeed Indicator (Knots)	Std
GX2 Instrument	Std
Tool Kit & Mast Strap Hold Down Strap	Std

Table 2 Section 6. Aircraft Weight Standard Equipment

6.2.3 Optional Equipment

OPTIONAL EQUIPMENT	FITTED (Yes/No)
BRS Emergency Parachute	
Radio	
Intercom	
Training Bars	
Disk Brakes	

Table 3 Section 6. Aircraft Weight Optional Equipment

6.3 Typical Aircraft Weights

Empty Weight + 172 kg crew + 1 hr Fuel (26.5 litres /19 kg)	403 kg	888 lb
Empty Weight + 86 kg pilot + full fuel (70 litres / 49kg)	347 kg	765 lb

Table 4 Section 6. Typical Aircraft Weights

**Aircraft Operating Instructions Edge XT 582 /Cruze
WEIGHT BALLENCE & EQUIPMENT**

6.3.1 Weighing Procedure

The wing should be lifted when assembled by routing a webbing strap around the king post top. The trike base should be lifted by the suspension point on the top of the mast.

Prior to weighing ensure that all fuel is drained and all baggage is removed from the aircraft. The weight, if changed due to option fitment should be recorded as a new issue and dated accordingly in section 6.2.

6.3.2 Weight Calculator

The weight calculator has been designed to assist in the calculation of maximum allowable fuel so that MTOW does not exceed 450kg. The calculator uses the typical empty weight of the microlight as stated above. Adjustments must be made if the microlight is not the "typical weight" i.e. if additional options are included.

Instructions

Find the intersection of the pilots weight versus the passenger weight (plus additional weight), this gives the maximum amount of fuel to be used without exceeding the MTOW.

6.3.3 Metric Fuel Calculator

Airborne XT Series Aircraft Fuel Volume Calculator (Metric)				Imperial	Metric												
Rear Occupant +20 kg Additional equipment	Rear Occupant+10 kg Additional	Rear Occupant kg	Front Occupant kg														
				60	65	70	75	80	85	90	95	100					
			0														
			5														
			10														
			15														
			20														
			25														
			30														
			35														
			40														
			45														
			50														
			55														
			60														
			65														
			70														
			75														
			80														
85																	
90																	
95																	
100																	
												UNIT CONVERSION					
												Gallons US	Litres	lb	kg		
												0.2642	1	2.205	1		
												2.9	11	11.0	5		
												4.8	18	22.0	10		
												6.6	25	33.1	15		
												8.5	32	44.1	20		
												10.3	39	55.1	25		
												12.2	46	66.1	30		
												14.0	53	77.2	35		
												15.9	60	88.2	40		
												17.7	67	99.2	45		
												18.5	70	110.2	50		
												14.5	55	121.3	55		
												15.9	60	132.3	60		
												17.7	67	143.3	65		
												18.5	70	154.3	70		
												Fuel capacity 70L subject to:		165.3	75		
												MTOW kg		450	176.4	80	
												Payload kg		223	187.4	85	
												Empty weight kg		212	198.4	90	
															209.4	95	
												Additional equipment:		220.5	100		
												eg BRS of 10kg		231.5	105		
												Fuel consumption at full power		242.5	110		
												L/Hr		26.5	253.5	115	
												32L=68 minutes useable fuel, full power		264.6	120		
Example: Pilot 80kg, 10kg additional equipment, Passenger 100kg = 67L fuel																	

Table 5 Section 6. Metric Fuel Calculator

Aircraft Operating Instructions Edge XT 582 /Cruze
WEIGHT BALLENCE & EQUIPMENT

6.3.4 Imperial Fuel Calculator

Airborne XT 912 Series Aircraft Fuel Volume Calculator Imperial (US)											Metric	Imperial							
Rear Occupant +40 lb Additional equipment	Rear Occupant +20 lb Additional Equipment	Rear Occupant	Front Occupant										UNIT CONVERSION						
			120	130	140	150	160	170	180	190	200	210	220	Gallons US	Litres	lb	kg		
60	80	100													0.2642	1	2.205	1	
70	90	110													1.0	3.8	1	0	
80	100	120													3.8	14.4	10	5	
90	110	130													5.4	20.4	20	9	
100	120	140	Tank filling volume calculated in US gallons										7.1	26.9	40	18			
110	130	150													8.8	33.3	70	32	
120	140	160													10.4	39.4	120	54	
130	150	170													12.1	45.8	160	73	
140	160	180												20.8	13.8	52.2	200	91	
150	170	190	FULL TANK										20.8	19.1					
160	180	200												20.8	19.1	17.4			
170	190	210												20.8	19.1	17.4	15.8		
180	200	220												20.8	19.1	17.4	15.8	14.1	
190	210													20.8	19.1	17.4	15.8	14.1	12.4
200	220													20.8	19.1	17.4	15.8	14.1	10.8
210														20.8	19.1	17.4	15.8	14.1	9.1
220														20.8	19.1	17.4	15.8	14.1	7.4
											Fuel capacity 18.5 gal(US) subject to:		400	181					
											MTOW lb		992	200					
											Payload lb		492	218					
											Empty weight lb		467	228					
													520	236					
											Additional equipment:		560	254					
											eg BRS of 20.7 lb		600	272					
											Fuel consumption at full power		640	290					
											7.0 gal / hr		992	450					
											9.1 gal = 71minutes useable fuel at full power								
Example: Pilot 200 lb, 20 lb additional equipment, Passenger 190 lb = 19.1 gallons of fuel maximum																			

Table 6 Section 6. Imperial Fuel Calculator

**Aircraft Operating Instructions Edge XT 582 /Cruze
WEIGHT BALLENCE & EQUIPMENT**

This page left blank intentionally

AIRCRAFT & SYSTEMS DESCRIPTION

AIRCRAFT & SYSTEMS DESCRIPTION	1
7 AIRCRAFT & SYSTEMS DESCRIPTION	2
7.1 General	2
7.2 Airframe	2
7.3 Flight Controls	2
7.4 Ground / Flight Control	3
7.5 Trimmer operation	3
7.6 Instrument panel	3
7.7 Undercarriage System	3
7.8 Seat Adjustment	3
7.9 Occupant restraint Harness	4
7.10 Engine	4
7.11 Propeller	4
7.12 Brake System	5
7.13 Electrical System	5
7.13.1 XT 582 Electrical Schematic	6
7.14 Pitot Static System and Instruments	7
7.15 GX2 Instrument Function	7
7.15.1 Description of Features	7
7.15.2 System Turn On	8
7.16 Emergency Parachute – Optional Equipment	9
7.17 Ignition Switches	9

7 AIRCRAFT & SYSTEMS DESCRIPTION

7.1 General

This section provides descriptions of the aircraft and its systems as well as methods of operation where appropriate.

Information on the aircraft flight controls is detailed in this section, but it is mandatory that you receive professional training prior to any solo flight. It is illegal to operate this aircraft in Australia without a licence issued by the HGFA or RAA.

7.2 Airframe

Wing

The Cruze wing is a high performance wire braced weight shift controlled micro light wings. The airframe is constructed from 6061-T6 multi sleeved aluminium tubing.

The keel and cross tubes are totally enclosed in the double surface. With the keel running parallel to the relative airflow, a decrease in drag is achieved. More importantly it enables the trike to be suspended from the aerodynamic centre of the wing giving greater roll and pitch authority. The wing is light and predictable in both the roll and pitch axis.

The multi sleeved leading edge construction is 63.5, 60.0 and 57.0 mm tube. This large diameter construction designed along with the sail luff curve, acts to preload the leading edge and maximise trailing edge tension throughout the speed range.

The sail is constructed using latest technology from the sail making industry. The leading edge is constructed using a PX 20 Mylar cloth. The main-sail cloth is 6 oz Dacron with a Mylar insert in leading edge pocket. A trailing edge band provides minimum stretch when loaded that not only gives long sail life, but also improves the top speed by controlling twist.

AirBorne wings are load tested in excess of 2450 kg. Excellent engineering contributes to the relatively lightweight of 50 kg.

Base

Attached to the wing by way of a universal joint is the trike base. The universal joint allows the free movement of the trike base in pitch and roll by which control is effected. The trike base includes the characteristic tricycle undercarriage, power plant and cockpit.

The engine is mounted to the engine platform at the base of the engine. A long-range fuel tank is mounted beneath the engine platform.

The pilot cockpit is designed to allow for various size pilots. The standard instruments used on the XT are a Skydat GX2 and additional analogue airspeed indicator in knots. The cockpit has soft sides attached to the pod and encloses the trike base tube and most of the fuel tank.

The maximum tyre pressure is 30 psi (205 kPa) and optimum pressure for general operations is 15 psi (103 kPa).

7.3 Flight Controls

Flight controls are as follows:

- Control bar move right = Left turn
- Control bar push out = Pitch up
- Push right toe = Throttle open
- Hand throttle forward = Throttle open
- Tighten trim cable = Slow trim

7.4 Ground / Flight Control

Ground Controls are as follows:

- Push left pedal = Taxi steering right
- Push Left Toe = Brakes on
- Ignition switch forward = Switch on
- Choke forward = Choke on
- Fuel Tap Aligned with tap body = Fuel on

7.5 Trimmer operation

The trimmer system allows in flight trim adjustment by rotating the trimmer wheel on the right downtube. Rotation of the trimmer wheel clockwise raises the reflex bridles causing extra reflex in the root section of the wing. This causes a reduction in trim speed of 10-15 knots. The swage on the trimmer wire is used as a pointer on the trimmer placard.

During take off and landing the recommended trimmer setting is in the fast trim position. It is acceptable to set the trim as far as mid trim position for take off and landing. The decal on the control frame upright, adjacent to the trimmer knob indicates the trim position.

There is a slight increase in roll pressures as the trimmer is used to decrease trim speed.

The aircraft is designed to be stable at trim under all loads with a small increase in trim airspeed as the AUW is increased.

7.6 Instrument panel



The instrument panel consists of an analogue airspeed indicator (knots) on the left side with the digital GX2 instrument mounted centrally in the dash. A power circuit breaker, power switch, 12V DC outlet and starter button can be found on the right side of the dash.

Figure 1 Section 7. Instrument Panel

7.7 Undercarriage System

The microlight uses a tricycle undercarriage with a braking system via a nose wheel drum brake unit. Oil dampened front shock absorbers are used.

The rear suspension is a swinging wish bone design in conjunction with a 45mm compression strut which houses an oil pneumatic shock absorber.

7.8 Seat Adjustment

The front seat backrest on the Edge XT trike has a simple for and aft adjuster on the base tube. To adjust the seat backrest forward the following procedure should be adopted:

- 1) Remove pin and bolt from channel.
- 2) Rotate seat back forward and replace bolt in channel one hole further forward.
- 3) Replace safety pin through bolt.

To move backrest rearward the bolt should be moved one hole back.

7.9 Occupant restraint Harness

Both front and rear seats are fitted with a 3-point restraint harness system. The shoulder inertia reel system is fitted to the mast and requires attachment on the male section of the lap belt during lap belt fastening (see photo).

When flying the trike solo it is important to fasten the rear seat belt to prevent contact with hot engine components in flight.

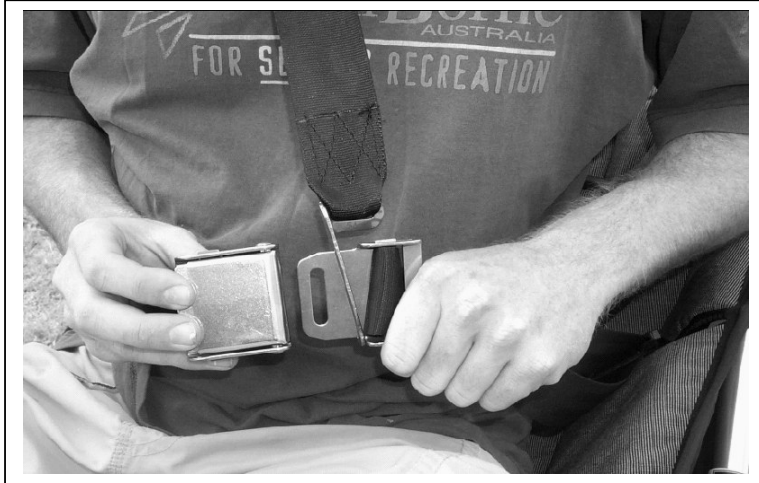

Figure 2 Section 7. Fastening Seat Belt with Shoulder Sash.

7.10 Engine

The power unit is a Rotax 582 UL DCDI / mod 99 65hp 2 stroke engine designed and built in Austria. The Rotax engine is fitted with a gearbox, which delivers smooth thrust via a reduction drive. This power unit is complemented with a ground adjustable propeller giving the ultimate in performance and reliability. The engine is fitted with Bing carburetors with an external dry filter.

7.11 Propeller

The aircraft is equipped with a 3-blade composite propeller with ground adjustable pitch. The hub is anodised alloy.

Two alternate propeller/hub configurations are available for use on the XT912, these include:

Warp Drive 3 Blade with Warp Drive hub

67.7 inches (1720 mm) diameter

Bolly BOS3 68 x 58 (Right hand version) with BOS 3 hub

68 inches (172.7 cm) diameter.

Engine	Propeller	Reduction Drive Ratio	Tip Angle to plane of rotation	Tip Angle to driveshaft axis
582 UL	Bolly	3.47	14°	76°
582 UL	Warp Drive	3.47	14°	76°

Table 1 Propeller pitch and gearbox ratio table

The propeller pitch setting and checking procedure is outlined in the Base Maintenance Manual. The pitch setting is determined as a part of certification of the aircraft. Settings outside this specification have an unknown effect on aircraft performance, and are not approved. Propeller pitch setting effects engine rpm. If the engine exceeds its rpm limits, check to see that the propeller pitch is set correctly.

7.12 Brake System

A front wheel drum brake system or an optional rear wheel disk brake system is used on the aircraft. Depressing the brake lever on the left hand side of the front footrest actuates the brake, on aerotow equipped trikes the aerotow release is the lever on the top left, painted yellow. A brake lever lock is provided. To engage, depress foot lever and raise locking lever by hand. To disengage, depress the foot lever.

Use wheel chocks when leaving the disk brake equipped aircraft unattended for a period of time.

Working Fluid for the Hydraulic Actuated Brake

Power transmission fluid. Similar to factory supplied fluid:

Castrol

TQ DEXRON III

Automatic transmission fluid

Fluid quantity	50	mL
Fill level	10	mm from top of housing.

Table 2 Brake Fluid Specifications

7.13 Electrical System

An electrical schematic for the aircraft is shown in the diagram on the following page.

The Electrical circuits comprise:

- an instrumentation circuit. The 12 V DC supply is protected by a 15 amp fuse at the battery and a 10 amp circuit breaker mounted on the dash. The master switch on the dash, when in the off position, disables the DC power socket, flight instrument and the electric start push button;
- an engine management circuit; and
- an ignition circuit.

It should be noted that the ignition circuit is a fail-safe system whereby the engine will run in the event of the ignition circuit becoming disconnected. Switching the coil to ground stops the engine.

When stopping the engine both switches on the side of the seat should be switched off. The master switch on the dash should then be turned to the off position to remove supply to the accessories.

If necessary the motor can be stopped using the chokes as detailed in section 3.3.10 of this issue of operating instructions.

Refer to the Rotax manual for more details for the engine electrical system.

7.13.1 XT 582 Electrical Schematic

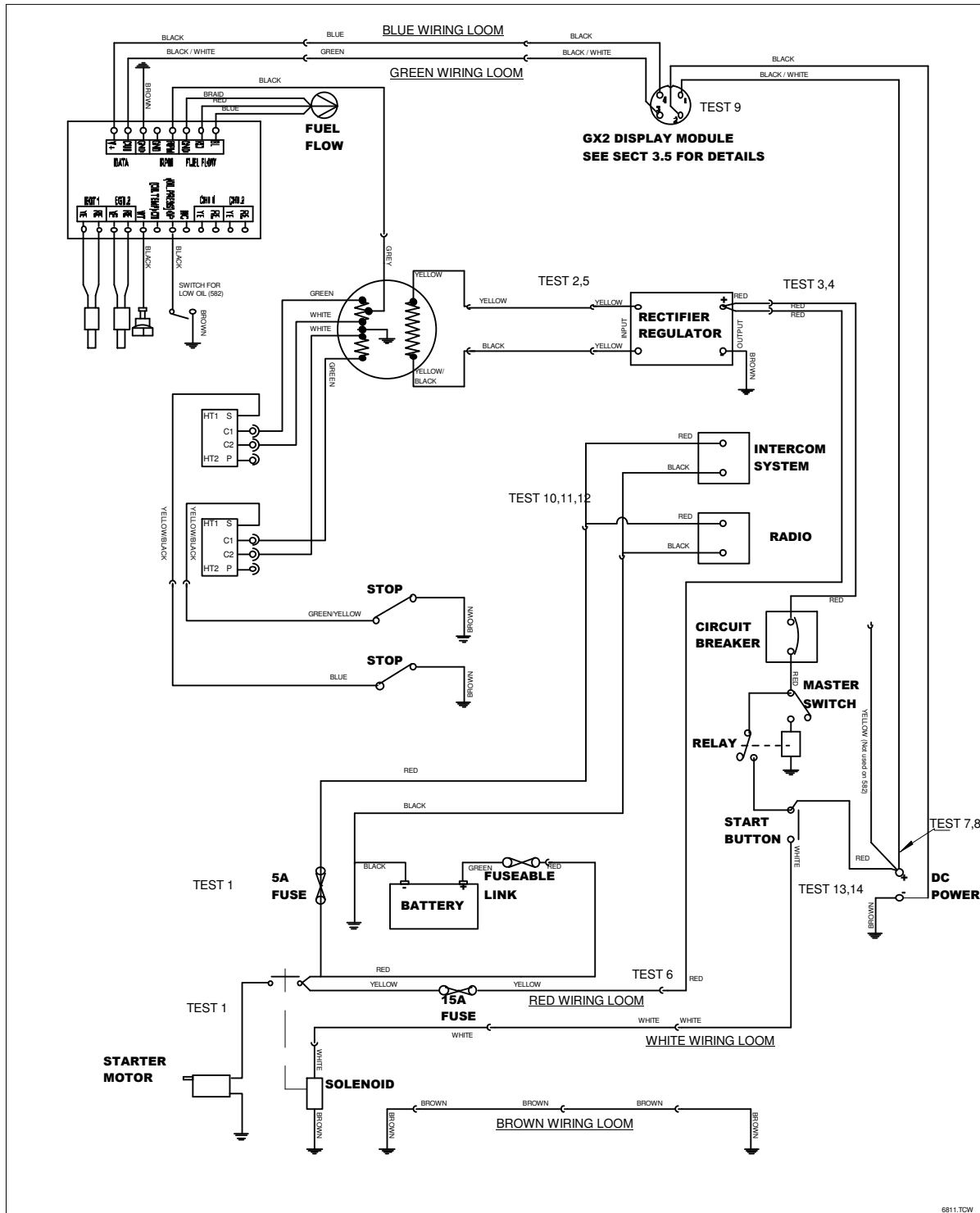

Figure 3 Section 7. Electrical Schematic

7.14 Pitot Static System and Instruments

The pitot static system supplies ram air pressure to the air speed indicator from the nose of the cockpit. The static pick up is at the rear of the instrument under the dash

7.15 GX2 Instrument Function

The GX2 instrument has preset alarm limit thresholds. If any of the temperature or pressure limitations are reached the red light will start to flash.

Standard instrumentation includes the AMPtronics GX2 Digital Flight Instrument (see description below) and an analogue airspeed indicator in knots.

WARNING

IT IS PROHIBITED TO FLY THIS AIRCRAFT WITH THE AMPTRONIC SKYDAT GX2 ALARM THRESHOLDS SET OUTSIDE THE ENGINE MANUFACTURER'S LIMITS.

7.15.1 Description of Features

The GX2 is a combined avionic instrument with programmable functions. The system consists of two parts: the display module, which is mounted in the dash, and the capture module, which is located on the engine tie rod. The photo shows the layout of the display when set up for the 582 Rotax engine.

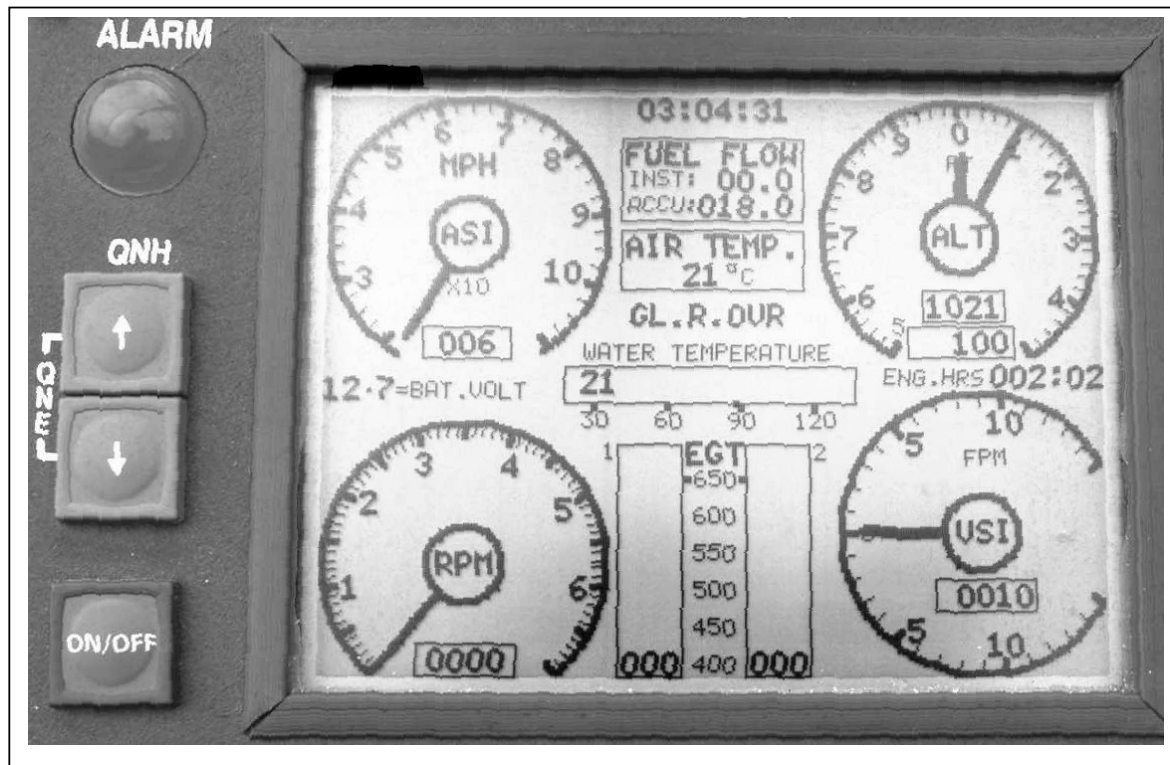

Table 3 Section 7. GX2 Display

GX2 Features

ASI mph, knots or kilometres	ALT (altimeter) in feet or metres
RPM (engine revolutions per minute)	VSI (vertical speed indicator) in m/s or ft/min
Flight duration, in hours, minutes, seconds	Air Temperature
Battery voltage	Water temperature in Celsius or Fahrenheit
Engine hours, in hours, minutes	2X EGT (exhaust gas temperature) Celsius or Fahrenheit
Accumulative fuel in litres or gallons	Fuel Flow in litres or gallons

Table 4 Section 7. GX2 Features**7.15.2 System Turn On**

Turn key clockwise to the on position. Press the “**ON/OFF**” push button of the panel. The alarm lamp will flash briefly. If the lamp does not flash it should be rectified prior to flight as the flashing lamp indicates an over temperature situation.

The display will light up prompting you to reset the flight duration to zero by pressing “**QNH+**”. If the fuel flow option is installed, to reset the accumulated fuel consumed press “**QNH-**”. After a few seconds the different engine measurement indications will be displayed. The green LED on the capture module should be continually flashing.

The preset engine limits can be checked against the limits outlined in section 2.4.2 by noting the position of the larger square bars on the LCD display for the particular gauge.

Altimeter Adjustment

You can adjust the barometric pressure as follows:

QNE - Depress both buttons $\uparrow\downarrow$ on the left of the instrument simultaneously to set at 1013mb.

QNH - Depress \uparrow to increase altitude pressure. Depress \downarrow to decrease altitude pressure.

The pressure display is right under "ALT" in the center of the altimeter. The readout below pressure display is a digital altimeter reading.

The preset limits can be checked against the limits outlined in section 2.4.2 by noting the position of the larger square bars on the LCD display for the particular gauge.

Changing System Units

At any time with the instrument turned on press and hold simultaneously the two QNH push buttons. After a few seconds the displayed units system will change and be memorized.

One of these unit systems can be changed from:

- Metric:**
 - Altitude in metres with QNH in mbar
 - ASI in km/h
 - VSI in m/s
 - Temperatures in Celsius
 - Fuel consumption in litres/h

2. Imperial (US)

- Altitude in ft with QNH in inches of Hg
- ASI in mi/h (statute)
- VSI in ft/min
- Temperatures in Fahrenheit
- Fuel consumption in gal (US)/h

3. Imperial (UK)

- Altitude in ft with QNH in mbar
- ASI in mi/h (statute) or knots
- VSI in ft/min
- Temperatures in Celsius
- Fuel consumption in litres/hour

The sequence of change is: **Metric** ←
Imperial (UK)
Imperial (US)
Imperial (UK) ASI in knots

NOTE

For Australian operations CASA requires the units to be set to Imperial (UK) with ASI in knots.

7.16 Emergency Parachute – Optional Equipment**NOTE**

The parachute is optional unless governing body of the country where the aircraft is to be flown requires a parachute.

WARNING

THE BRS EMERGENCY PARACHUTE RECOVERY SYSTEM INSTALLATION HAS BEEN APPROVED BY CASA ON THE BASIS THAT, WHILST NOT DEPLOYED, IT WILL NOT CAUSE HAZARD TO THE AEROPLANE, ITS OCCUPANTS OR GROUND PERSONNEL.

CASA HAS NOT APPROVED THE SYSTEM ITSELF OR CONSIDERED IN WHAT CIRCUMSTANCES, IF ANY, IT MIGHT BE USEFULLY DEPLOYED THE SYSTEM HAS NOT BEEN DEMONSTRATED TO BE EFFECTIVE IN SAFELY RECOVERING THE AEROPLANE.

The BRS emergency parachute system has a double acting firing mechanism. The parachute-operating handle is fitted with a safety pin and is located on the left side of the seat frame. This pin should be removed before each flight and the safety pin must be replaced before the pilot alights from the aircraft. A force of approximately 15 – 20 kg pull on the actuating handle is required to activate the BRS rocket motor.

Emergency procedures for use of the BRS can be found in section 3.3.9 of this manual. Additional information including service and maintenance requirements can be found in the BRS manual.

7.17 Ignition Switches

The ignition switches are located on the lower right side of the seat frame. Operation is forward for on and rearward for off. When the switches are in the off position the switch shorts the engine coils to earth causing the engine to stop.

This page left blank intentionally

HANDLING SERVICE AND MAINTENANCE

HANDLING SERVICE AND MAINTENANCE	1
8 HANDLING SERVICE AND MAINTENANCE	2
8.1 Introduction	2
8.2 Identification Plate	2
8.3 Aircraft Documents	2
8.4 Aircraft Inspection, Maintenance and repair	2
8.5 Fuel System	2
8.5.1 Filling Fuel Tanks	2
8.5.2 Fuel Specification	2
8.5.3 Fuel Sampling	3
8.5.4 Checking Fuel	3
8.5.5 Draining the Fuel	3
8.6 Engine Lubricating Oil	3
8.7 Rotary Valve Lubrication	3
8.8 Gearbox Lubrication	3
8.9 Cooling System	4
8.10 Tyre Inflation	4
8.11 Shock Struts	4
8.11.1 Rear Shocks	4
8.11.2 Front Shocks	4
8.12 Brakes	4
8.12.1 Working Fluid for the Hydraulic Actuated Brake	4
9 Circuit Breaker and Fuses	6
9.1 Parking and Ground Handling	6

8 HANDLING SERVICE AND MAINTENANCE

8.1 Introduction

This section contains factory recommended procedures for proper ground handling and routine care for your aircraft. Included in this section is relevant information required by the operator.

WARNING

IT IS THE PILOT'S RESPONSIBILITY TO ENSURE THAT ALL AIRWORTHINESS DIRECTIVES HAVE BEEN ADDRESSED. IT IS ALSO THE PILOTS RESPONSIBILITY TO ENSURE SERVICING AND MAINTENANCE HAS BEEN PERFORMED AS OUTLINED IN THE APPROPRIATE MAINTENANCE MANUAL AND IN ACCORDANCE WITH THE APPLICABLE AVIATION REGULATIONS.

8.2 Identification Plate

The aircraft has two identification plates. The wing identification plate can be found on the negative plate of the universal bracket. The base identification plate can be found on the seat mast block on the left side of the aircraft. The Serial number should be quoted when corresponding with the factory.

8.3 Aircraft Documents

The Aircraft Operating Instructions are one of a series of documents required to safely operate this aircraft. A document list can be found in section 0 of this manual under DATA PACKAGE.

8.4 Aircraft Inspection, Maintenance and repair

Maintainer qualifications vary from country to country. The operator / maintainer should be familiar with the local requirements. Maintenance requirements are outlined in the base maintenance manual for the base unit and in the wing maintenance manual for the wing. The following sections have been included because it is considered that the information may be required on a more regular basis.

8.5 Fuel System

8.5.1 Filling Fuel Tanks

The properties of the fuel tank material cause an increase in capacity after the first 2 to 3 tanks of fuel. Initial capacity is 64 litres with the "aged" capacity 70 litres. The fuel level markings have been positioned for the fuel tank capacity at 70 litres.

The XT has a single fuel tank. When the tank is being filled there may be a slight pressure differential between the sides of the tank, causing the fuel cap side to fill slightly faster than the other side. Allow time for the breather valves to equalise the pressure to allow complete filling and, check that both sides are sufficiently full. Fill to the neck of the fuel entrance.

8.5.2 Fuel Specification

FUEL	
Preferred Fuel Type	En228 Premium/Regular. Super grade gasoline, lead free, min RON 90
Optional Fuel Type	AVGAS (see note)

Table 1 Section 8. Fuel Specification

NOTE: Due to higher lead content in AVGAS deposits in the combustion chamber will increase. Therefore, use AVGAS only if you encounter problems with vapour lock or if the other fuel type is not available. Use of AVGAS requires higher frequency maintenance intervals. If AVGAS is used the Rotax web site should be referenced for maintenance requirements. Refer to section 2.12 for fuel capacities and limitations.

8.5.3 Fuel Sampling

There is a draincock on the base of the fuel tank at the left hand side, which may be used to check the quality of the fuel, and to drain fuel if necessary, it is especially important to remove any water that may have been introduced from the system.

8.5.4 Checking Fuel

The fuel is checked for water and contaminants by draining a sample of the fuel into a clear glass container. Once a sample has been taken the quality of the fuel can be checked by looking for any water at the bottom of the glass, and checking for any other visual contaminants.

If the fuel has been sitting for an extended period without use it is advisable to replace it with fresh fuel.

8.5.5 Draining the Fuel

Ensure that a suitable receptacle is found for the fuel that is to be drained, position the trike above the receptacle and depress the draincock. Ensure that there are no ignition sources and that the fuel is disposed of correctly.

8.6 Engine Lubricating Oil

Engine lubrication is supplied via the oil injection system which is gravity fed. The oil consumption is defined by engine rpm and the lever position. The lever is actuated via a Bowden cable connected to the throttle cable. The oil injection system has a capacity of 2 litres. The nominal oil usage is 50:1 (2%) which would require 1.4 litres for a full tank of fuel.

The oil tank has a low oil level switch, which actuates the alarm on the SkyDAT instrument. However if the oil tank is filled when the fuel tank is filled the low level alarm should never come on. The remaining quantity of oil is 500mL when the alarm is actuated which leaves enough oil to find a suitable landing

WARNING

THE OIL INJECTION TANK HOLDS ENOUGH OIL TO LUBRICATE 100 LITRES OF FUEL. THE OIL INJECTION TANK SHOULD BE FILLED EVERY TIME THE FUEL TANK IS FILLED.

area. Oil Specifications

Oil used is Super two stroke ASTM/CEC standards, API-TC classification (consult your Rotax dealer for a recommended oil to suit your operating environment).

8.7 Rotary Valve Lubrication

Rotary valve lubrication is supplied via a small tank mounted on the top right hand side of the engine.

Oil quantity on a new installation is approximately 310mL. Before every flight check the oil level (approximately mid height of the bottle). If there is a notable consumption of oil (in excess of 1 ccm/hr) look for a leak. If a leak cannot be found consult the Rotax Maintenance Manual.

Oil Specifications

Oil used is Super two stroke ASTM/CEC standards, API-TC classification (consult your Rotax dealer for a recommended oil to suit your operating environment).

8.8 Gearbox Lubrication

The gearbox on the XT582 is inverted and in this configuration requires 400 mL of oil. See maintenance manual for further details.

Oil Specifications

Gear oil API-GL5 or GL6, SAE 140 EP or 85W – 140 EP

8.9 Cooling System

WARNING

DO NOT OPEN THE COOLING SYSTEM WHEN THE ENGINE IS HOT. SEVERE SCALDING AND OTHER INJURIES MAY RESULT.

The water level in the overflow bottle should be checked prior to flight. The level should be between the low and high mark on the overflow bottle. Water-cooling system capacity is 4.0 L. See maintenance manual for further details.

Coolant Specification

Rotax specifies use of: 50% antifreeze concentrate with additives against corrosion and 50% pure water, or use of an equivalent premixed coolant.

AirBorne has had satisfactory results using the brand Nulon Red which is silicate free and is a Mono Ethylene Glycol product containing 1040 gm glycol per litre.

8.10 Tyre Inflation

The recommended tyre inflation pressures are 15 PSI for both the front and rear tyres. When checking the tyre pressures the opportunity should be taken to examine the tyres for wear, cuts, bruises, slippage and other defects.

8.11 Shock Struts

8.11.1 Rear Shocks

WARNING

SPECIALISED PUMPS MUST BE USED FOR THE AIR SHOCKS – PRESSURES UP TO 600 PSI EXIST.

The rear shocks are pressurised to 580 psi using a schrader valve system. A special pump will be necessary to repressurise the rear shocks to the correct setting. There should be no reason why the rear shock would need to be reinflated, and if they do then a proper investigation of the cause should be undertaken.

8.11.2 Front Shocks

The front shocks should be inflated to 50 psi for each reservoir. The top should be inflated first. Turn the rebound damper fully clockwise, and then anticlockwise for twelve clicks.

8.12 Brakes

8.12.1 Working Fluid for the Hydraulic Actuated Brake

Power transmission fluid. Similar to factory supplied fluid:

Castrol

TQ DEXRON III

Automatic transmission fluid

Fluid quantity	50	mL
Fill level	10	mm from top of housing.

Top up instructions:

1. Access by turning steering to the left and approach from under side of fairing on full faired versions
2. Remove reservoir plug (this is the most rearward plug on the master cylinder). Remove the coarse green grit cover filling from the cap to enable the insertion of the Allen key (refer to the following figure).



Figure 1 Brake master cylinder, remove reservoir plug

3. Using a syringe, fill reservoir with auto transmission fluid. Visually sight the level to be approximately 10mm from top of housing and replace plug. The level may be sighted from inside the cockpit, by stretching the front wheel draught stop out of the way. A clean matchstick may be a useful dipstick.

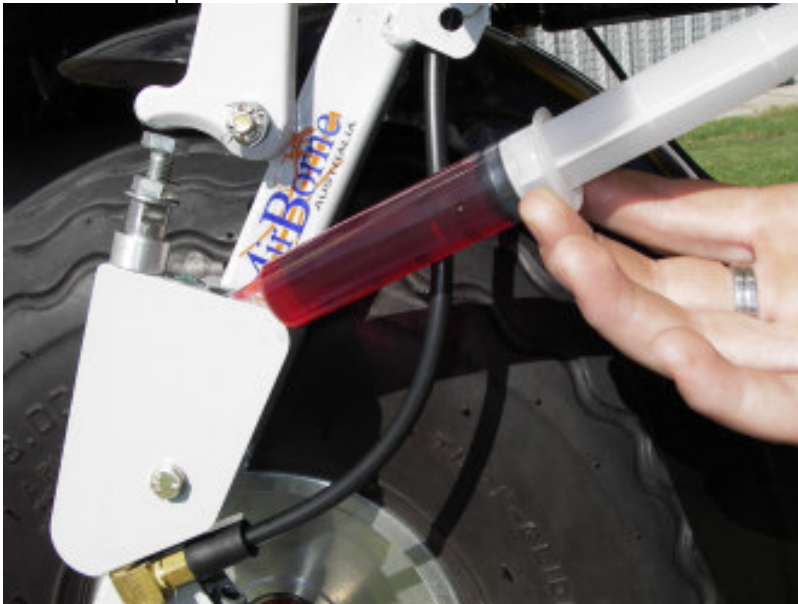

Figure 2 Brake fluid top up

Replace the reservoir plug. Replace the grit cover cap filling into the reservoir plug, to make future access and cleaning easy.

9 Circuit Breaker and Fuses

The fuses for the electrical equipment are located in two positions.

1. The Lynx intercom system has a 1.5A fuse screwed into the side of the box where the headsets and push to talk cables are plugged in.
2. The power supply cables for the radio are protected at the rear of the aircraft with inline fuses which terminate at the right hand side of the mast block. A 5A fuse is to be used for the radio and intercom power supply. The fuse holder is marked with the correct Current rating for the fuse.
3. The battery charging circuit is protected with a 20A fuse, which also terminates at the right hand side of the mast block. The fuse holder is marked with the correct Current rating for the fuse.
4. A 10 A circuit breaker is located on the right hand side of the dash. The circuit breaker protects the dash instrumentation and the DC socket.

9.1 *Parking and Ground Handling*

Parking and ground handling information can be located in section 4.

SUPPLEMENTS

SUPPLEMENTS	1
9 TRAINING SUPPLEMENT	2
9.1 XT582 Cruze Flight Training Supplement	2
9.2 Assembly and Break Down	2
9.3 Aircraft Operation	2
9.4 Startup	2
9.5 Take-off	2
9.6 Cruise and Stalls	3
9.7 Landing	3
9.8 Emergency Procedures	3
9.9 Control Locations & Operation	3
9.9.1 Flight Controls	3
9.9.2 Engine Controls	3
9.9.3 Digital Instrument Panel (SkyDat GX2)	4
9.10 Aircraft Performance Data	5
9.11 Training Recommendations	5
9.11.1 Landing	5

9 TRAINING SUPPLEMENT

9.1 XT582 Cruze Flight Training Supplement

This supplement is intended to outline the unique characteristics of the XT 582 weight-shift control (WSC) airplane. It is not intended to outline all aspects of a WSC aircraft. The supplement is intended to be used by a pilot / operator who already has extensive knowledge of WSC aircraft operation. The performance, procedures and unique features of the XT are summarized here and the details are referenced to the appropriate section within the AOI.

Normal Procedures found in Section 4 of the Aircraft Operating Instructions (AOI) covers all the Normal Procedures in detail.

9.2 Assembly and Break Down

Sections 4.2 to 4.4 and 4.11 to 4.41 outline wing assembly and break down procedures for the aircraft. Airborne suggests assembling the wing on the control frame as this method keeps the sail off the ground resulting in less chance of the wing being soiled or damaged.

The wing can be assembled and installed on the base by one person. The mast has a gas-assist strut to help lift the wing into place above the base unit.

It should be noted that the batten tips utilise a unique hinged catch system to secure the battens to the trailing edge. This system allows easy installation and provides extraordinary flexibility in wing tuning (see wing Maintenance Manual for tuning instructions).

IT IS EXTREMELY IMPORTANT THAT THE MAST LEVER IS LOADED CORRECTLY ONCE THE MAST IS RAISED WITH THE WING INSTALLED. SEE 4.4.10 FOR FURTHER DETAILS (SEE PHOTO OPPOSITE).

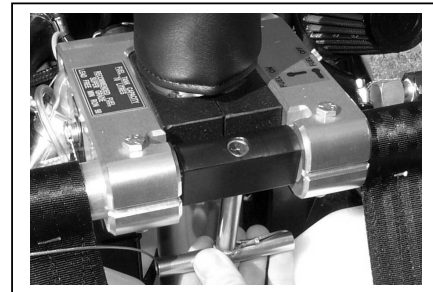

AOI Section 4.3 contains the wing pre-flight inspection checklist while AOI Section 4.5 contains the base and engine pre-flight checklist.

Figure 1 Section 9. Mast Cam Lever

9.3 Aircraft Operation

Aircraft operation information is contained in AOI Sections 4.8 to 4.10. Section 4.9 covers normal flight operations in checklist form while 4.10 amplify those procedures in detail.

9.4 Startup

See AOI Sections 4.8 and 4.9.1-2 for engine start-up details.

The master switch should be turned on (keyed switch on the panel) then depress the SkyDAT on/off switch for 3 seconds. The instrument display will now power up. Ensure that the fuel tap is in the on position and both ignition switches are on. Once satisfied that all other checks as outlined in section 4.9.1-2 are complete the starter button on the right side of the dash can be depressed.

Warm up the engine. Minimum temperature should be reached before take off. Operate for 2 min at 2000 rpm continue at 2500 rpm until minimum temperature of 50 deg C (140° F) is reached.

9.5 Take-off

See AOI Section 4.9.3-5 and 4.10.3-6 (Amplified Procedures) for take off and climb procedures. Many WSC instructors recommend pulling the control bar in towards the pilot past the wings trim position after lift off. As the Streak and the Cruze wing design has the trim speed equal to or greater than 1.3 V_s

(stall speed) it is not necessary to “pull” the control bar back. The wing will return to the trim speed and achieve take off safety speed if the controls are relaxed.

Initial climb out should be made on full power for maximum take off weight. Approximately 2/3 of maximum take off power is considered comfortable for a minimum weight takeoff. Take off distance will be extended at reduced power.

Once climb is established power should be reduced to below maximum continuous power of 5500 rpm. A minimum of takeoff safety speed should be used. At this speed the aircraft would round out nicely into a glide should the engine fail.

Finally, the wing trimmer located on the lower right down tube should be in the fast trim position (see AOI Section 7.5).

9.6 Cruise and Stalls

Cruise and stalls are covered in AOI Sections 4.10.7 and 4.10.8 respectively.

Stalls are very mild in the Streak and Cruze wings, and in fact, very difficult to do unless the aircraft is heavily loaded. Recovery is the same as in other WSC aircraft.

9.7 Landing

See AOI Section 4.9.7-8 for descent and landing procedures.

It is not necessary to approach at a higher speed than trim speed unless conditions are extremely turbulent. Generally trim speed allows an adequate margin for landing. Set the wing trimmer in the fast trim position.

9.8 Emergency Procedures

See AOI Section 3 for emergency procedures.

9.9 Control Locations & Operation

9.9.1 Flight Controls

The XT 582 has standard WSC flight controls. See Section 7 for a complete description of the aircraft and its systems.

9.9.2 Engine Controls

Control	Location and Operation
Master Switch (turn on for starter and SkyDat instrument panel)	Lower right instrument panel. Use key to turn on. (See AOI Section 7.6)
Starter Button	Lower right instrument panel below Master Switch. Push button to engage starter. (See AOI Section 7.6)
Choke Lever	Left side of pilot mounted to seat frame. Push lever down to turn choke on.
Foot Throttle	Right foot above the nose wheel steering bar.
Ignition Switches	Right side of pilot mounted to seat frame. Switches moved forward to turn ignition on.
Hand Throttle	Right side of pilot mounted to seat frame above ignition switches. Push throttle up and forward to increase power.

9.9.3 Digital Instrument Panel (SkyDat GX2)

See AOI Section 7.16.1 for a complete description.

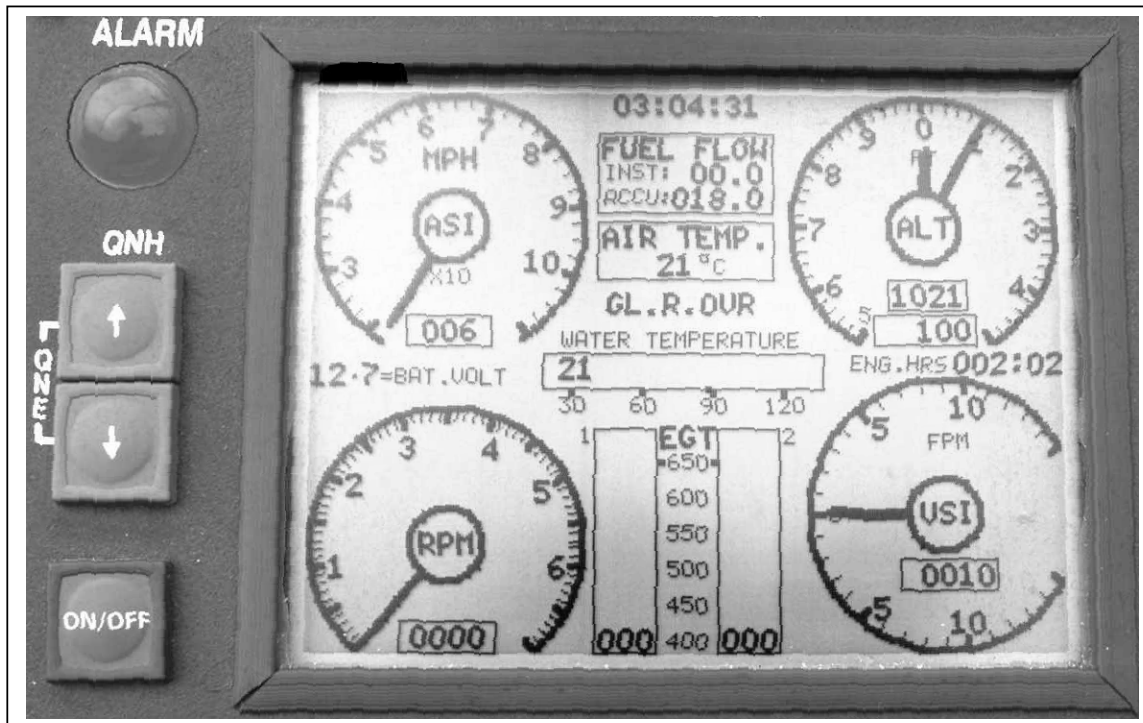

Figure 2 Section 9. GX2 Display

The initial display provides Timer and Cumulative Fuel reset options. To reset these counters press the corresponding QNH button.

After a few seconds the display will change to that depicted above. The following **primary instruments** are provided:

Instrument	Location
ASI	Top left corner
Altimeter	Top right corner (use up/down QNH buttons to adjust barometric pressure)
RPM (engine – the propeller is spinning at slightly less than half this value)	Lower left
VSI	Lower right
Voltmeter	Center left between ASI and RPM
Hour Meter	Center right between ALT and VSI
Water Temperature	Middle center
EGT (Exhaust Gas Temp)	Bottom center

9.10 Aircraft Performance Data

See AOI Section 5 for detailed discussion on performance. The information provided below is based on standard atmospheric conditions at sea level at Maximum Take Off Weight (MTOW):

Distances are specified for:

Sea Level with:

Max Take Off Power

A level dry runway

With short grass

Still wind

And temperature of 15 deg C.

	XT 582 - CRUZE
Take off / Landing distance over 50' obstacle	280m (918')
Stall at 450kg MTOW:	34 kt (39mph)
Glide Ratio	7.1:1 @ 45kt (14%)
Average Fuel Burn at Cruise:	14 lt/hr (3.7 gph)

9.11 Training Recommendations

The XT 582 handles predictably in all flight regimes so there are no unique training requirements in any area except landing. Like all WSC aircraft aerobatic maneuvers are strictly prohibited.

9.11.1 Landing

Most weight shift microlight pilots are unprepared for the speed of the XT aircraft's approach to landing. Some weight shift microlight aircraft approach to land at 35-40 mph or less. The XT's approach is in the order of 55-60 mph with the Cruze wing. As previously stated, it is not necessary to pull the control bar in past the trim position with the Cruze wings. Fly the final approach at trim speed and flare normally. You will notice that the approach is also flatter than most weight shift controlled aircraft allowing for a smoother, less abrupt flare out to land.

End of Aircraft Operating Instructions